



FITTING INSTRUCTIONS FOR CP0389BL
AERO CRASH PROTECTORS
DUCATI PANIGALE 1199 '12-, 899 '13-, 1299 '15- & 959 '16-



Picture A



Picture B

THIS KIT CONTAINS THE ITEMS PICTURED AND LABELLED BELOW.
DO NOT PROCEED UNTIL YOU ARE SURE ALL PARTS ARE PRESENT.

Please note that the way the kit is packed does not necessarily represent the way of mounting to the bike

THE PARTS SHOWN MAY BE REPRESENTATIVE ONLY (FOR CLARITY OF INSTRUCTIONS ONLY)

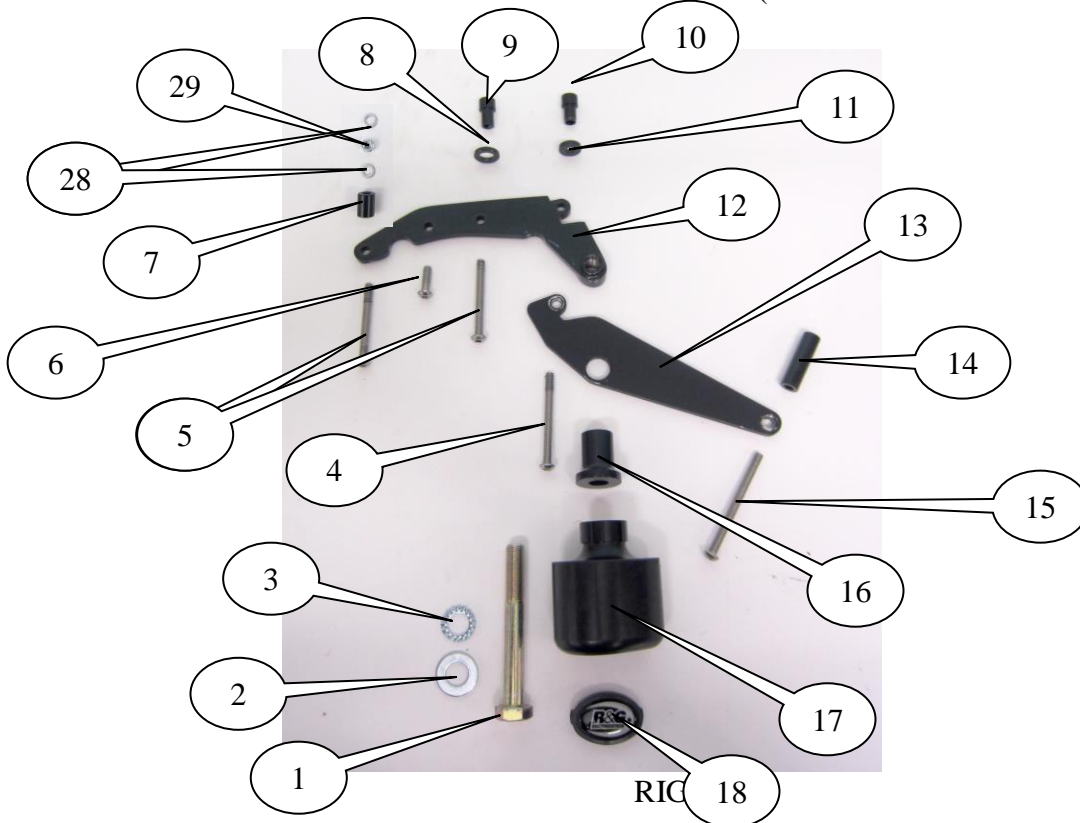

R&G Racing

Unit 1, Shelley's Lane, East Worldham, Alton, Hampshire, GU34 3AQ

Tel: +44 (0)1420 89007 Fax: +44 (0)1420 87301 www.rg-racing.com Email: info@rg-racing.com

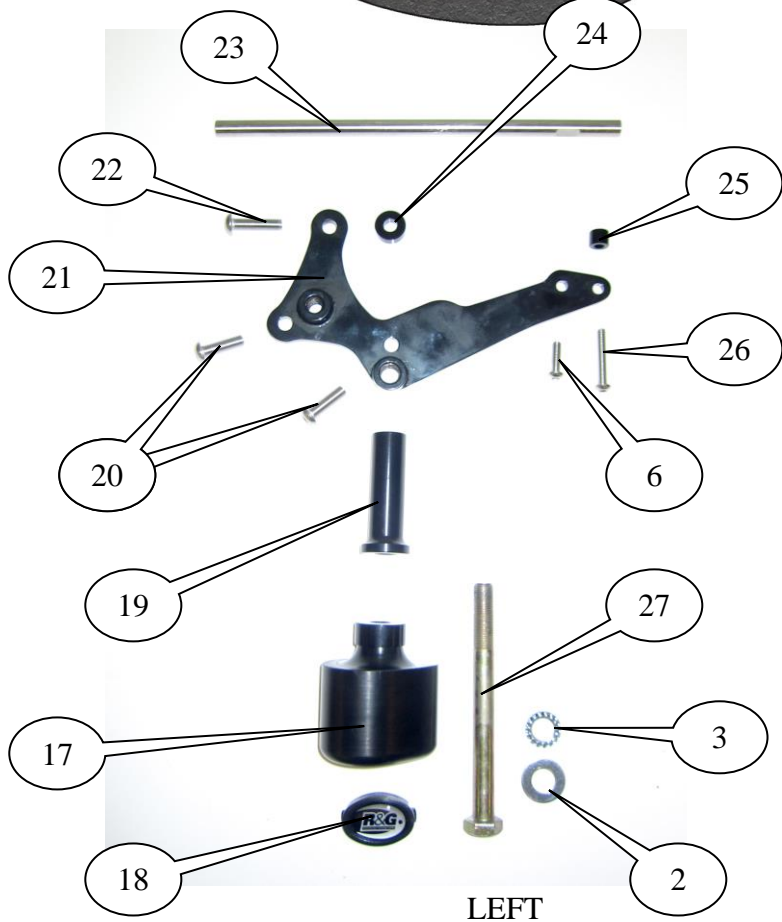

LEFT

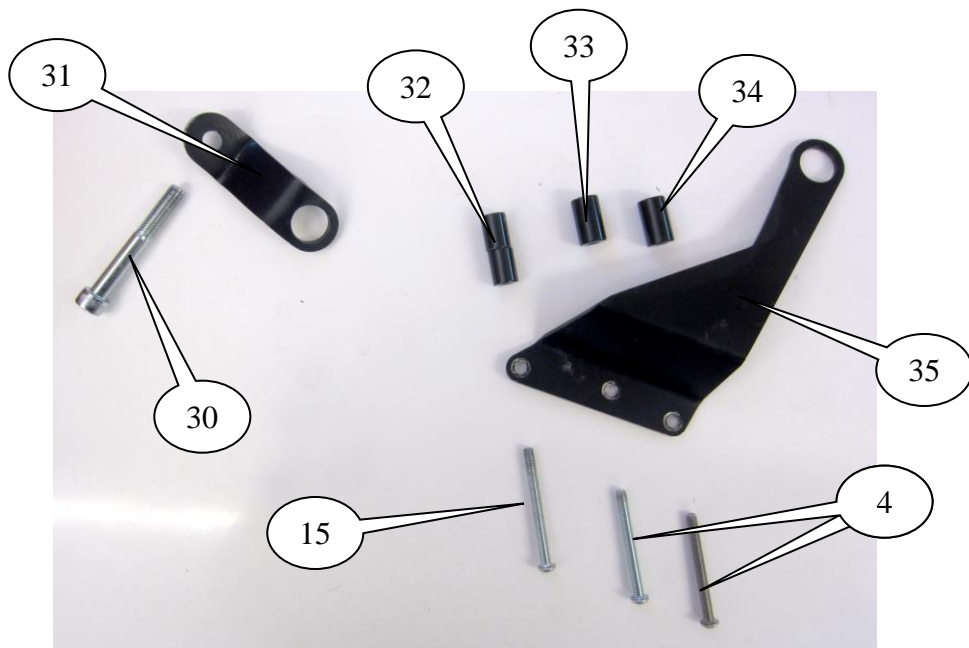

SUPPORT BRACES



LEGEND

- ITEM 1 = M12x1.25x90mm LONG HEX HEAD BOLT (x1).
ITEM 2 = M12 WASHERS (x2).
ITEM 3 = LOCK-WASHERS (LW0001) (x2).
ITEM 4 = M6x65mm LONG BUTTON HEAD BOLT (x3).
ITEM 5 = M6x55mm LONG BUTTON HEAD BOLTS (x2).
ITEM 6 = M6x20mm LONG BUTTON HEAD BOLTS (x2).
ITEM 7 = PLASTIC SPACER (S0792) (16.5mm long) (x1).
ITEM 8 = SPACER (S0758) (3mm long – 9.2mm ID) (x1). *** FOR 1199 '12-'13 ONLY ***
ITEM 9 = SPACER (S0737) (23.5mm long - stepped) (x1).
ITEM 10 = SPACER (S0756) (23.5mm long – double stepped) (x1).
ITEM 11 = SPACER (S0757) (3mm long – 8.2mm ID) (x1). *** FOR 1199 '12-'13 & 899 '13- ***
ITEM 12 = RIGHT MOUNTING PLATE REAR (M0383 Welded Assembly) (x1).
ITEM 13 = RIGHT MOUNTING PLATE FRONT (M0384) (x1).
ITEM 14 = SPACER (S0735) (41.5mm long) (x1).
ITEM 15 = M6x70mm LONG BUTTON HEAD BOLT (x2).
ITEM 16 = SPACER (S0739) (31mm long) (x1).
ITEM 17 = CRASH PROTECTOR (B0431 with CS340) (x2).
ITEM 18 = CRASH PROTECTOR CAPS (BC0002) (x2).
ITEM 19 = SPACER (S0738) (72mm long) (x1).
ITEM 20 = M8x25mm LONG BUTTON HEAD BOLTS (x2).
ITEM 21 = LEFT MOUNTING PLATE (M0382 Welded Assembly) (x1).
ITEM 22 = M8x30mm LONG BUTTON HEAD BOLT (x1).
ITEM 23 = EB077 ENGINE BAR (252.5mm long) (x1).
ITEM 24 = SPACER (S0736) (6.5mm long) (x1).
ITEM 25 = SPACER (S0670) (9mm long) (x1).
ITEM 26 = M6x35mm LONG BUTTON HEAD BOLT (x1).
ITEM 27 = M12x1.25x130mm LONG HEX HEAD BOLT (x1).
ITEM 28 = M6 WASHERS (x2).
ITEM 29 = M6 STAINLESS NUT (x1).
ITEM 30 = M10 x 1.25 x 50mm LONG 10.9 GRADE CAP HEAD BOLT (x1).
ITEM 31 = LEFT BRACE PLATE (MP0116) (x1).
ITEM 32 = SPACER (S0793) (40mm long) (x1).
ITEM 33 = SPACER (S0794) (36.5mm long) (x1).
ITEM 34 = SPACER (S0795) (35mm long) (x1).
ITEM 35 = RIGHT BRACE PLATE (MP0117) (x1).

Please note that in cases where kits are packed with rubber washers holding the components onto the bolt – *the rubber washers should be thrown away!*

TOOLS REQUIRED

- Socket set to include 2.5, 3, 4, 5, 6, 7 & 8mm A/F socket and wrench.
- Socket set to include a deep 8mm & 19mm socket and wrench.
 - 8 & 10mm spanner.
 - Flat headed screwdriver.
 - Torque wrench (up to 40Nm).
- Suitable centre lift stand to support the chassis during rear suspension removal.

R&G Racing

Unit 1, Shelley's Lane, East Worldham, Alton, Hampshire, GU34 3AQ

Tel: +44 (0)1420 89007 Fax: +44 (0)1420 87301 www.rg-racing.com Email: info@rg-racing.com



TOWARDS REAR
OF BIKE

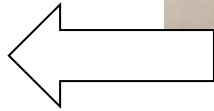

TOWARDS FRONT
OF BIKE



PICTURE C

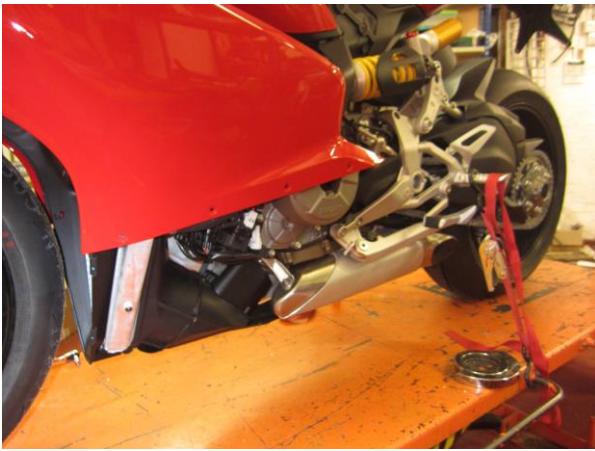

Picture 1



Picture 2

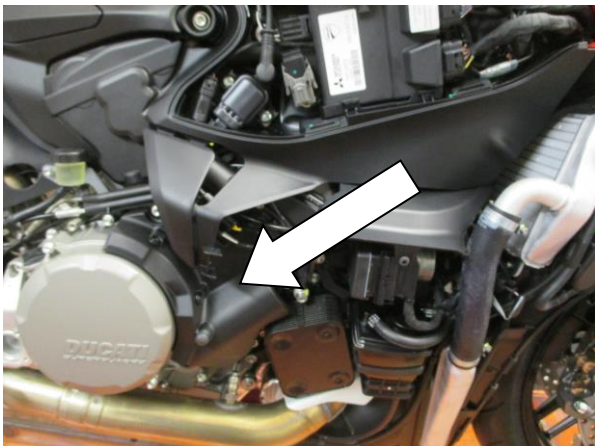

Picture 3

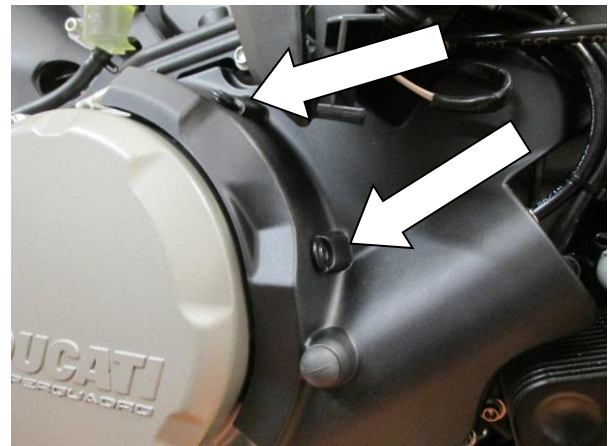

Picture 4

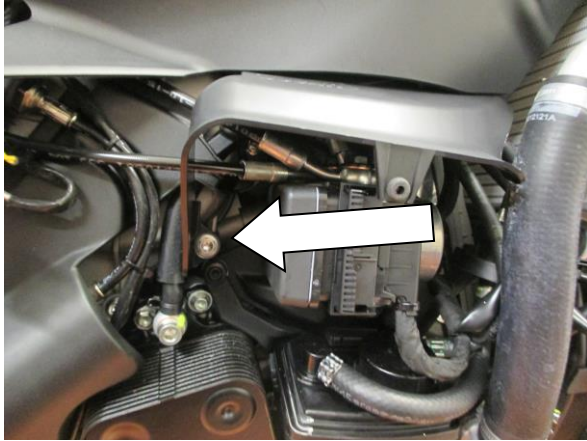

Picture 5



Picture 6



Picture 7

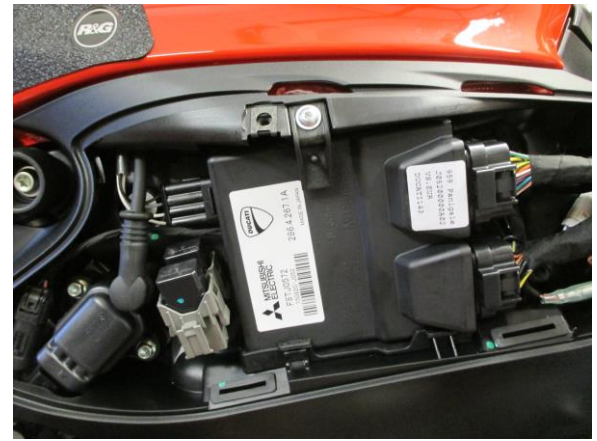

Picture 8

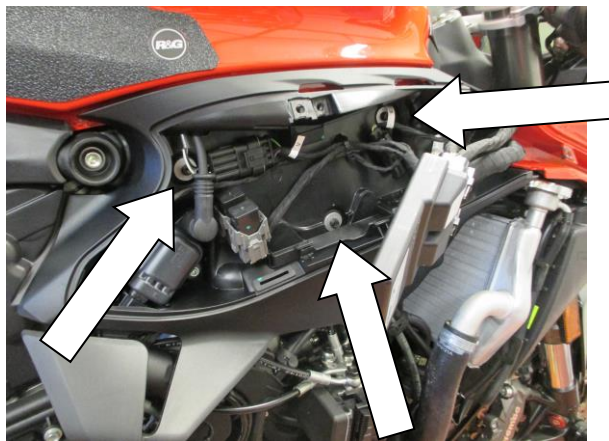

Picture 9



Picture 10



Picture 11



Picture 12



Picture 13



Picture 14

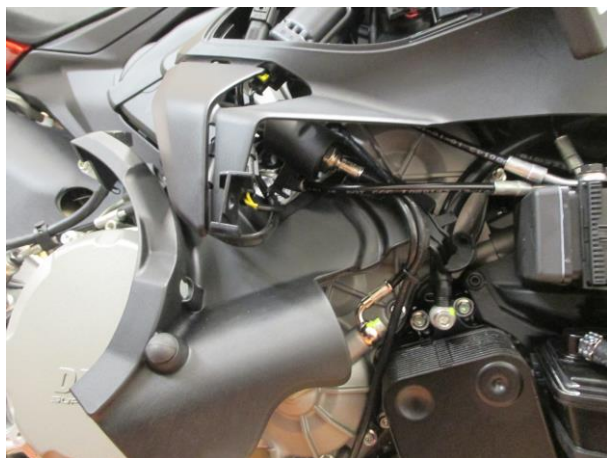

Picture 15



Picture 16

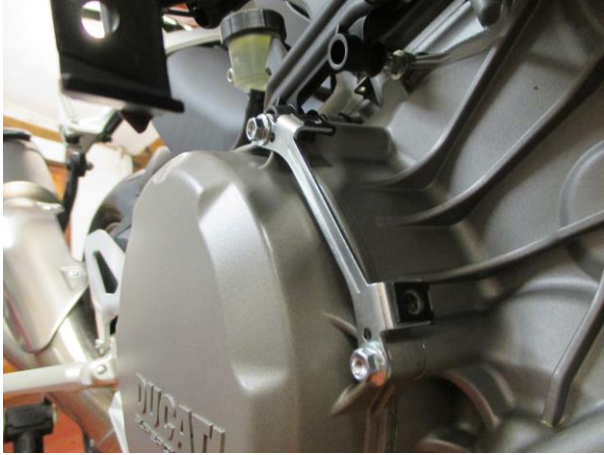

Picture 17



Picture 18



Picture 19

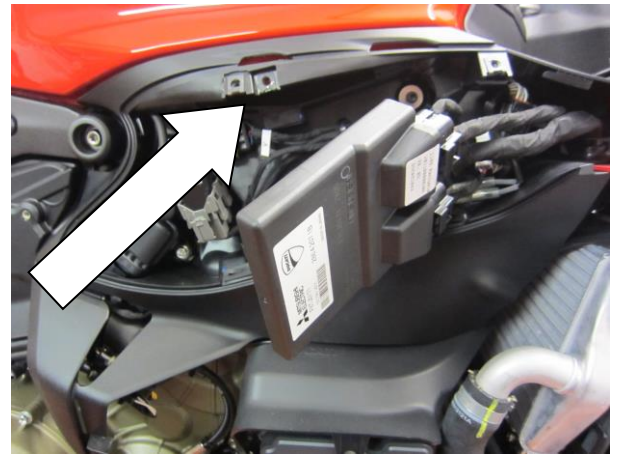

Picture 20



Picture 21



Picture 22



Picture 23

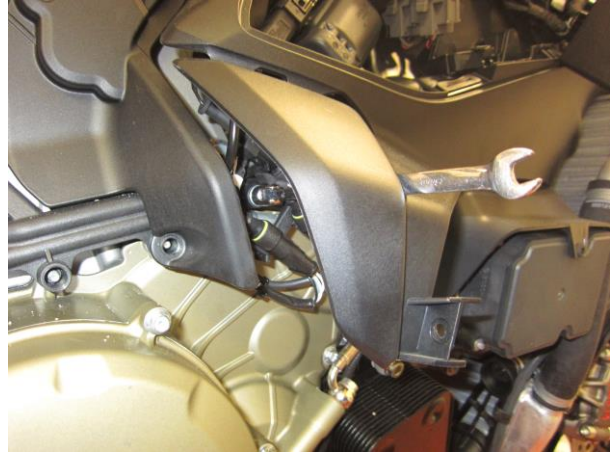

Picture 24



Picture 25



Picture 26



Picture 27



Picture 28



Picture 29



Picture 30

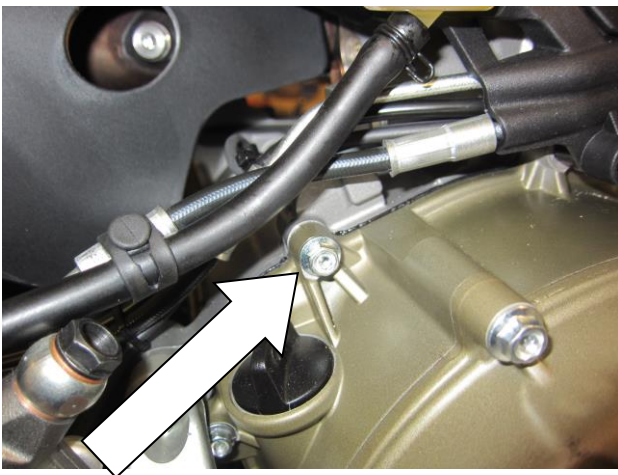

Picture 31



Picture 32



Picture 33

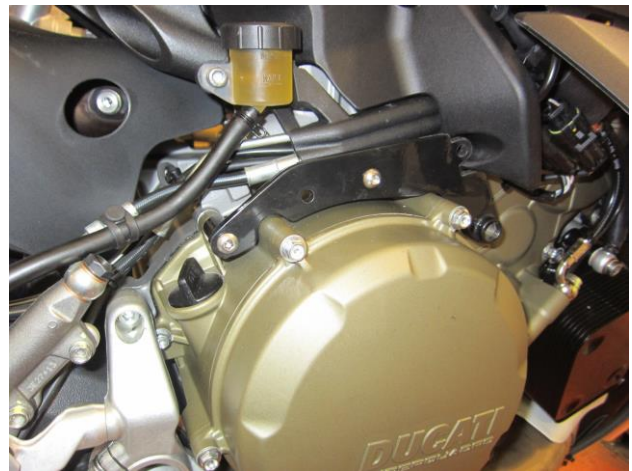

Picture 34



Picture 35

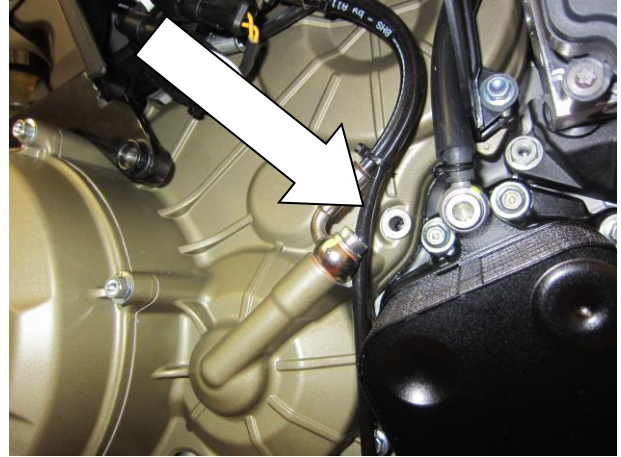

Picture 36

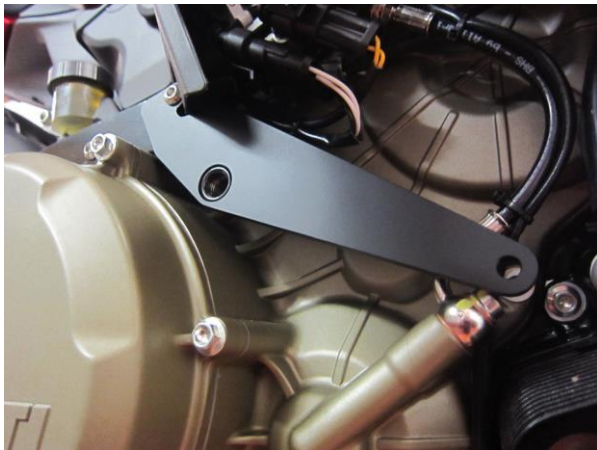

Picture 37

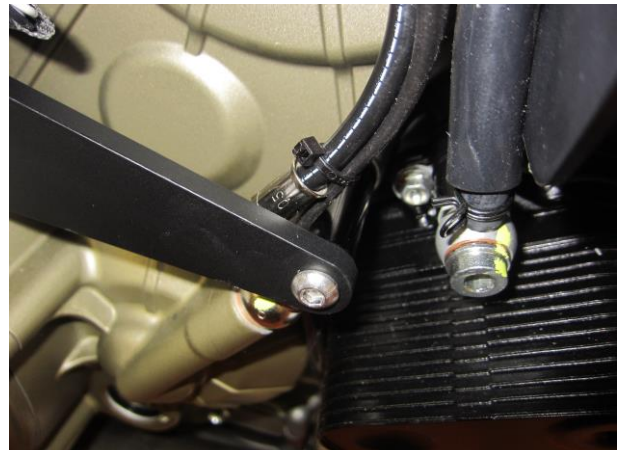

Picture 38



Picture 39



Picture 40



Picture 41

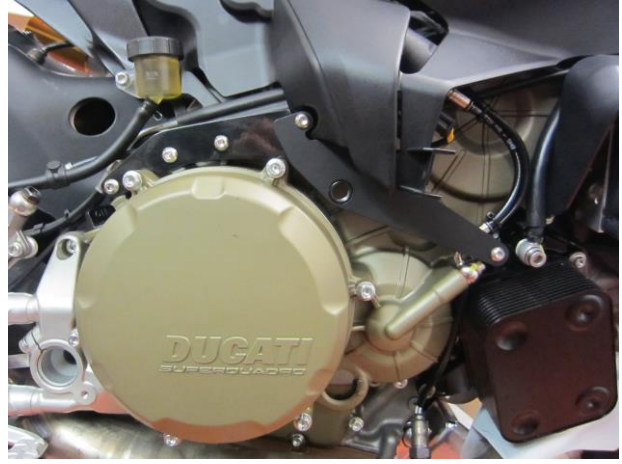

Picture 42



Picture 43



Picture 44

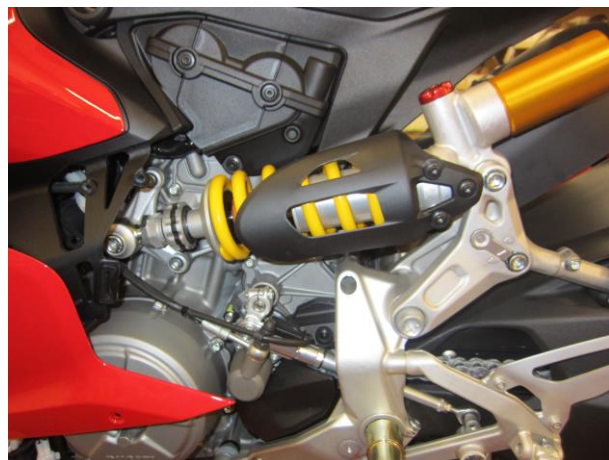

Picture 45



Picture 46

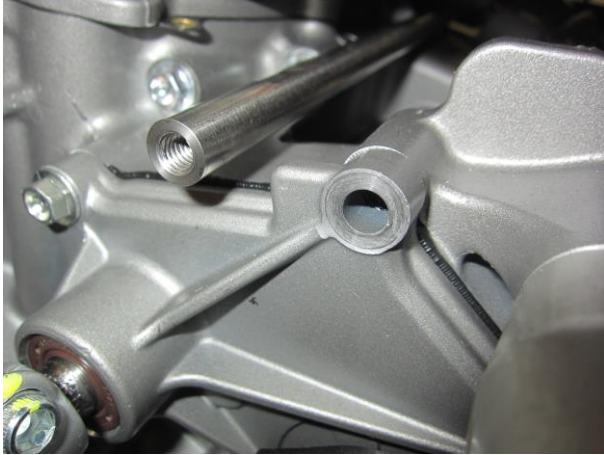

Picture 47



Picture 48



Picture 49



Picture 50



Picture 51



Picture 52



Picture 53



Picture 54



Picture 55

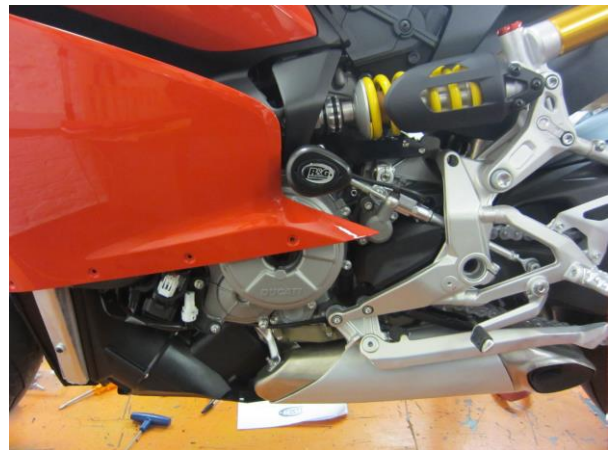

Picture 56



Picture 57



Picture 58

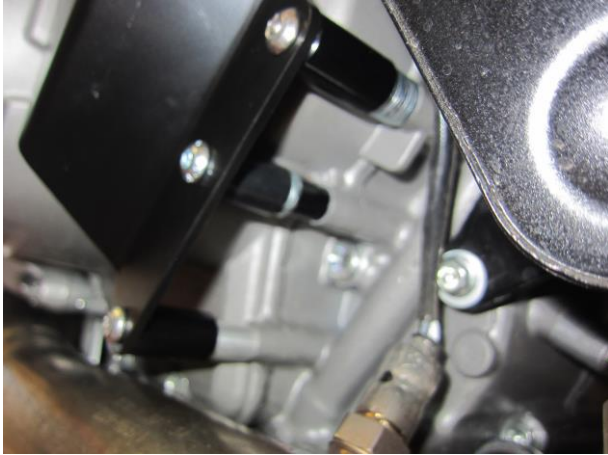

Picture 59



Picture 60



Picture 61



Picture 62

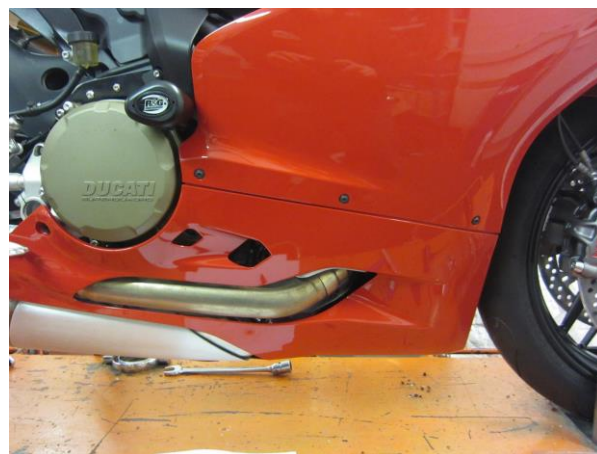

Picture 63



FITTING INSTRUCTIONS

- Remove the lower fairings from both sides of the bike. To do this, remove the row of fairing bolts on either side which attach the lower to the upper fairing, along with the fairing bolts at the rear by the swingarm pivot, the three bolts underneath the bike and the two bolts which are accessible on the inside cowling surrounding the lower radiator, as shown in picture 1.
- On the right side of the bike, the upper fairing also needs to be removed. Remove the five fairings bolts along with the push rivet on the inner cowling (*on the 1299 '15- & 959 '16- this push rivet has been replaced with a 2.5mm button head bolt*) before gently pulling the fairing out of its locating tabs, as shown in picture 2.
- **On the 959 '16- only** – To fit the crash protectors, the plastic cover that is arrowed in picture 3 needs to be permanently removed from the bike.
- Remove the two bolts that secure the cover to the engine case, as arrowed in picture 4.
- Remove the two bolts that secure the front and rear of the cover for the ABS control unit, as arrowed in picture 5 and as shown being accessed with a long Allen key or T-bar in picture 6.
- Remove the plastic cover from the bike, as shown in picture 7.
- Remove the plastic clip which is bolted in place and secures the electronic box in place, allowing the electronic box to be gently pulled clear of the bike, as arrowed in picture 8 & 9.
- Remove the three 4mm bolts that are now accessible that secure the plastic panel in place, as arrowed in picture 9.
- With these items unbolted, they can now be gently pulled away from the immediate work area to gain access for the next step, as shown in picture 10.
- Remove the nut that secures the front of the plastic cover that is being removed, as shown in picture 11.
- Remove the wiring connectors from their plastic mounts by sliding them off, as shown in picture 12.
- Access can now be gained to the hex head bolt cap underneath and can now be removed, as shown in picture 13.
- Remove the two 8mm hex head bolt caps which secure the plastic hose guide in place, as shown in picture 14.
- The plastic cover can now be removed from the bike as shown in picture 15 but is a little tricky. *Both mounts need to be lifted clear of the protruding thread of the engine case studs and towards the front there are hose guides which need to be freed from their hoses. Once clear of the studs, gently pull downwards and twist out from the rear, as shown in picture 15. There is a metal insert in the lower mount of the plastic cover, be careful to avoid this contacting and marking the engine case during removal.*
- With the plastic cover removed, the mounting bracket is clearly visible, as shown in pictures 16 & 17.
- Remove the two engine case bolts that secure this in place and remove the bracket.
- Re-fit the two engine case bolts without the bracket and re-torque the bolts to the manufactures specified amount.
- Re-fit the plastic ABS control unit cover, using the original bolts, as shown in picture 18.
- **On the 1199 '14- only** – *On the right side of the bike, remove the two 8mm hex head bolt caps which secure the plastic hose guide in place, as shown in picture 19.*
- *Remove the plastic clip which is bolted in place and secures the electronic box in place, allowing the electronic box to be gently pulled clear of the bike, as arrowed in picture 20.*
- *Remove the three 4mm bolts that are now accessible that secure the plastic panel in place, as shown in picture 21.*
- *Remove the two bolts that secure the plastic cylinder head cover in place, as shown in picture 22.*
- *With these items unbolted, they can now be gently pulled away from the immediate work area to gain access for the next step, as shown in picture 23.*
- On all model variants, remove the two 8mm hex head bolt caps which secure the plastic hose guide in place, as shown in picture 19, and remove the remaining 8mm hex head bolt cap which secure the hose guide in place at the front, as shown in picture 24. *To make it easier remove the wiring connectors from their plastic mounts by sliding them off.*

R&G Racing

Unit 1, Shelley's Lane, East Worldham, Alton, Hampshire, GU34 3AQ

Tel: +44 (0)1420 89007 Fax: +44 (0)1420 87301 www.rg-racing.com Email: info@rg-racing.com



- This will now allow the plastic hose guide to be pulled out and up to gain access to remove the spacers and studs, as shown in picture 25. *Un-clipping the hose from the rear of the plastic may allow for more manoeuvrability of the plastic hose guide.*
- Remove the two spacers and then the studs using a deep 8mm socket, as shown in picture 26 & 27.
- Take the single stepped spacer (item 9 – S0737 – 23.5mm long) and insert it into the rearward hole from behind the plastic hose guide, as shown in picture 28.
- Do the same for the double stepped spacer (item 10 – S0756 – 23.5mm long) on the remaining hole, as shown in picture 29.
- The plastic hose guide should now relocate into place, with both spacers aligning with the bolt holes in the engine case, as shown in picture 29.
- ***On the 1199 '14- the plastic cylinder head cover and electronics box plastics can be relocated into place, with the lower mount of the plastic cylinder head cover locating over the smaller step of spacer S0756, as shown in picture 29.***
- *On the 899 '13- fit the small spacer with the smaller diameter centre (item 11 – S0757 – 3mm long) over the exposed smaller step of spacer S0756, as shown in picture 30..*
- ***On the 1199 '12 – '13 fit the small spacer with the smaller diameter centre (item 11 – S0757 – 3mm long) over the exposed smaller step of spacer S0756 and the remaining small spacer (item 8 – S0758 – 3mm long) over the exposed section of the other spacer, S0737.***
- On all model variants, remove the remaining 8mm head engine case bolt, as arrowed in picture 31.
- Take the right side rearward mounting plate (item 12 – M0383) and fit one M6 x 55 long button head bolt (item 5) through the rearward hole and then through the plastic spacer (item 7 – S0792 – 16.5mm long). Now fit one M6 washer (item 28), followed by the M6 nut (item 29) and then the remaining M6 washer (item 28), as shown in picture 32.
- Tighten the nut onto the bolt so that it just begins to tighten onto the plastic spacer.
- Now the right side rearward mounting plate with the rearward bolt can be offered up to the bike as shown in picture 33.
- Take the remaining M6 x 55mm long button head bolt (item 5) and place through the third hole from the rear, locating through the set of spacers already fitted which secure the rear of the plastic hose guide in place, before loosely tightening into the engine case, as shown in picture 34.
- To ensure the rear bolt is correctly mounted into the engine case, tighten the bolt into the casing and then lock it using the M6 nut which is already fitted. This will allow the plastic spacer to be slightly pinched in place and will help absorb forces in the event of a crash.
- ***On the 1199 '14- the cut-out on the front of the plate should fit around the plastic, as shown in picture 35.***
- Re-fit the front 8mm hex head bolt cap to secure the front of the plastic hose guide in place, as shown in picture 35 and relocate any wiring connectors that were previously un-mounted.
- Remove the engine case bolt from behind the hydraulic hose, as arrowed in picture 36.
- Offer the right side forward mounting plate (item 13 – M0384) into place, ensuring the large hole locates over the threaded boss of the previously installed mounting plate, before fitting the M6 x 65mm long button head bolt (item 4) through the top mounting hole, then the other mounting plate and spacers before loosely tightening into the engine case, as shown in picture 37.
- Take the long spacer (item 14 – S0735 – 41.5mm long) and position it between the mounting plate and engine case in alignment with the front mounting hole, before inserting the M6 x 70mm long button head bolt (item 15) and loosely tightening, as shown in picture 38.
- With all four mounting bolts now in place and the mounting plates correctly mounted, tighten the bolts to the manufacturers recommended torque settings, as shown in picture 39.

R&G Racing

Unit 1, Shelley's Lane, East Worldham, Alton, Hampshire, GU34 3AQ

Tel: +44 (0)1420 89007 Fax: +44 (0)1420 87301 www.rg-racing.com Email: info@rg-racing.com



- **On the 1199 '14- only** - ensure the plastic electronics box is correctly located before re-fitting the three bolts which secure it in place, as shown in picture 40. Re-fit the electronics box in place along with the small plastic clip and bolt, before tightening. Also re-fit the two bolts that secure the plastic cylinder head cover in place.
- From the left side of the bike, insert the engine bar (item 23 – EB077 – 252.5mm long) behind the rear cylinder, allowing the other end to locate with the remaining hole on the right side mounting plate. *Please note: insert the engine bar so that the end with the 8mm spanner flats sits on the left side of the bike, as shown in picture 41.* Fit one M6 x 20mm long button head bolt (item 6) through the mounting plate and loosely tighten into the engine bar.
- Picture 42 shows how the mounted assembly should look on the Panigale 1199 '14-.
- Picture 43 shows how the mounted assembly should look on the Panigale 899 '13-.
- The motorcycle now needs to be mounted onto a suitable stand which supports the bike from the swingarm pivot to allow for the rear suspension to be removed, as shown in picture 44. The rear wheel will also need to be supported to prevent it from dropping when the shock absorber is removed.
- Remove the small plastic panel which mounts in front of the front shock absorber mount, before removing the two bolts which secure the shock absorber in place, as shown in picture 45.
- With the shock absorber removed, remove the three bolts which secure the front mounting plate in place to the rear cylinder head, as shown in picture 46.
- Remove the engine case bolt which sits near the previously installed engine bar and above the rear shock linkage, as shown in picture 47.
- Take the left side mounting plate (item 21 – M0382) and offer it up to the bike as shown in picture 48. Insert one M8 x 25mm long button head bolt (item 20) through the front hole of the mounting plate and into the threaded boss on the side of the cylinder head, also shown in picture 48.
- On the top mounting hole, place the M8 x 30mm long button head bolt (item 22) through the mounting plate, then through the short spacer (item 24 – S0736 – 6.5mm long) and loosely tighten into the thread boss on the side of the rear cylinder head, as shown in picture 49.
- Fit the remaining M8 x 25mm long button head bolt (item 20) into the remaining of the three mounting holes, above the threaded boss.
- At the rear of the mounting plate, fit the M6 x 35mm long button head bolt (item 26) through the mounting plate hole, then through the small spacer (item 25 – S0670 – 9mm long) and loosely tighten into the engine case, as shown in picture 50.
- The previously fitted engine bar should now be in a location where it can align with the remaining hole on the mounting plate. Fit the remaining M6 x 20mm long button head bolt (item 6) and loosely tighten into the engine bar, as shown also in picture 50.
- With the mounting plate correctly mounted it should look like picture 51. Tighten all the bolts to the manufacturers recommended torque settings. For the bolt that tightens into the engine bar, hold the engine bar in place using an 8mm open ended spanner on the flats of the bar, whilst tightening the button head bolt, as shown in picture 41. *Please ensure to tighten the button head bolt on the other end of the engine bar as well.*
- Re-fit the shock absorber to the bike using the OEM bolt on the rear mount but using the M10 x 1.25 x 50mm long 10.9 grade cap head bolt supplied in the kit (item 30) on the front mount. When fitting, first place through the recessed OEM spacer and then fit through the smaller hole of the left brace plate (item 31 – MP0116) so that the bend in the plate comes out from the bike, as shown in pictures 52 & 53. *Tighten this loosely, so that the brace can still be moved.*
- The crash protector can now be fitted. Slide one of the 12mm washers (item 2) onto the M12 x 1.25 x 130mm long hex head bolt (item 27) so the washer sits against head of bolt.
- Slide one serrated locking washer (item 3) over the bolt so it sits against the washer just fitted.
- Next slide the bolt with washers through either crash protector (item 17) so head of bolt and washers goes into counter-bore in bobbin.
- Locate the longer crash protector spacer (item 19 – S0738 – 72mm long) over the exposed end of the bolt, ensuring the larger diameter end sits against the crash protector, as shown in picture 54.

R&G Racing

Unit 1, Shelley's Lane, East Worldham, Alton, Hampshire, GU34 3AQ

Tel: +44 (0)1420 89007 Fax: +44 (0)1420 87301 www.rg-racing.com Email: info@rg-racing.com



- Offer the crash protector up to the mounting plate by locating the spacer through the larger hole in the left brace plate and tighten the bolt into the main mounting plate, as shown in picture 55, taking care to ensure the wiring runs above the spacer.
- Tighten the bolt until you feel some compression from inside the protector using a 19mm socket and wrench, as shown in picture 56. **PLEASE NOTE THE CRASH PROTECTOR MUST BE POSITIONED AS IN PICTURE 'C' WITH BIGGER END TOWARD FRONT OF BIKE.** Turn a little more so that you feel the compression increase slightly. Then apply a quarter turn. Do not over tighten as damage can occur to the bike. Do not exceed 40Nm of torque.
- Tighten the front shock bolt. Do not exceed 40Nm of torque.
- On the right side of the bike, remove the three M6 bolts which mount into the lower casing, as shown in picture 57.
- Take the right brace plate (item 35 – MP0117) and offer it up to the bike as shown in picture 58.
- Fit two M6 x 65mm long button head bolts (item 4) through the two forward holes on the bottom of the plate and the remaining M6 x 70mm long button head bolt (item 15) through the remaining rear hole, as shown in picture 59.
- On the back of the plate locate the 40mm long spacer (item 32 – S0793 – 40mm long) over the exposed thread of the rearward bolt, the 36.5mm long spacer (item 33 – S0794 – 36.5mm long) over the central bolt and the 35mm long spacer (item 34 – S0795 – 35mm long) over the front bolt, as shown in picture 59.
- The brace plate should now be securely located in place as shown in picture 58.
- Take one of the 12mm washers (item 2) and slide onto the M12 x 1.25 x 90mm long hex head bolt (item 1) so the washer sits against head of bolt.
- Slide one serrated locking washer (item 3) over the bolt so it sits against the washer just fitted.
- Next slide the bolt with washers through the remaining crash protector (item 17) so head of bolt and washers goes into counter-bore in bobbin.
- Locate the remaining crash protector spacer (item 16 – S0739 – 31mm long) over the exposed end of the bolt, ensuring the larger diameter end sits against the crash protector, as shown in picture 60.
- Locate the crash protector and spacer through the upper hole of the brace plate and tighten the bolt into the main mounting plate, as shown in picture 61.
- Tighten the bolt until you feel some compression from inside the protector using a 19mm socket and wrench. **PLEASE NOTE THE CRASH PROTECTOR MUST BE POSITIONED AS IN PICTURE 'C' WITH BIGGER END TOWARD FRONT OF BIKE.** Turn a little more so that you feel the compression increase slightly. Then apply a quarter turn. Do not over tighten as damage can occur to the bike. Do not exceed 40Nm of torque.
- Re-fit the small plastic cover by the rear shock on the left side of the bike.
- Re-fit the upper fairing on the right and lower fairings on both sides of the bike, as shown in pictures 62 & 63.
- Ensure the fairings are correctly fitted with all bolts fully tightened.
- If not already fitted fit bubble stickers into recess of both crash protector caps.
- Fit crash protector caps into both crash protectors.

ISSUE 2 26/01/2016 (AR)

CONSUMER NOTICE

The catalogue description and any exhibition of samples are only broad indications of the Products and R&G may make design changes which do not diminish their performance or visual appeal and supplying them in such state shall conform to the order. The Buyer acknowledges no representation or warranty (other than as to title) has been given or will apply to the Products other than those in R&G's order or confirmation and the Buyer confirms it has chosen the Products as being of merchantable quality and suitable for its particular purposes. Where R&G fits the Products or undertakes other services it shall exercise reasonable skill and care and rectify any fault free of charge unless the workmanship has been disturbed. The Buyer is responsible for ensuring that the warranty on the motorcycle is not affected by the fitting of the Products. On return of any defective Products R&G shall at its option either supply a replacement or refund the purchase money but shall not be liable if the Products have been modified or used or maintained otherwise than in accordance with R&G's or manufacturer's instructions and good engineering practice or if the defect arises from accident or neglect. Other than identified above and subject to R&G not limiting its liability for causing death and personal injury, it shall not be liable for indirect or consequential loss and otherwise its liability shall be limited to the amounts paid by the Buyer for the Products or the fitting or service concerned. These terms do not affect the Buyer's statutory rights.

R&G RACING RETURNS POLICY (NON-FAULTY GOODS)

Returns must be pre-authorised (if not pre-authorised the return will be rejected). Goods may only be returned direct to us if they were purchased direct from us (customer must prove if necessary). Otherwise to be returned to original vendor. Goods must be in re-sellable condition, in the opinion of R&G Racing. All returns are subject to a 25% restocking and handling fee (25% of the gross value exc. P&P – at the prevailing price at time of purchase). The customer must pay any and all carriage charges. No returns of discontinued products, unless within 14 days of purchase. This policy does not affect your statutory rights and does not refer to faulty goods.

R&G Racing

Unit 1, Shelley's Lane, East Worldham, Alton, Hampshire, GU34 3AQ

Tel: +44 (0)1420 89007 Fax: +44 (0)1420 87301 www.rg-racing.com Email: info@rg-racing.com



INSTRUCTIONS DE MONTAGE POUR CP0389BL
PROTECTIONS CRASH
DUCATI PANIGALE 1199 '12-, 899 '13-, 1299 '15- & 959 '16-



Photo A

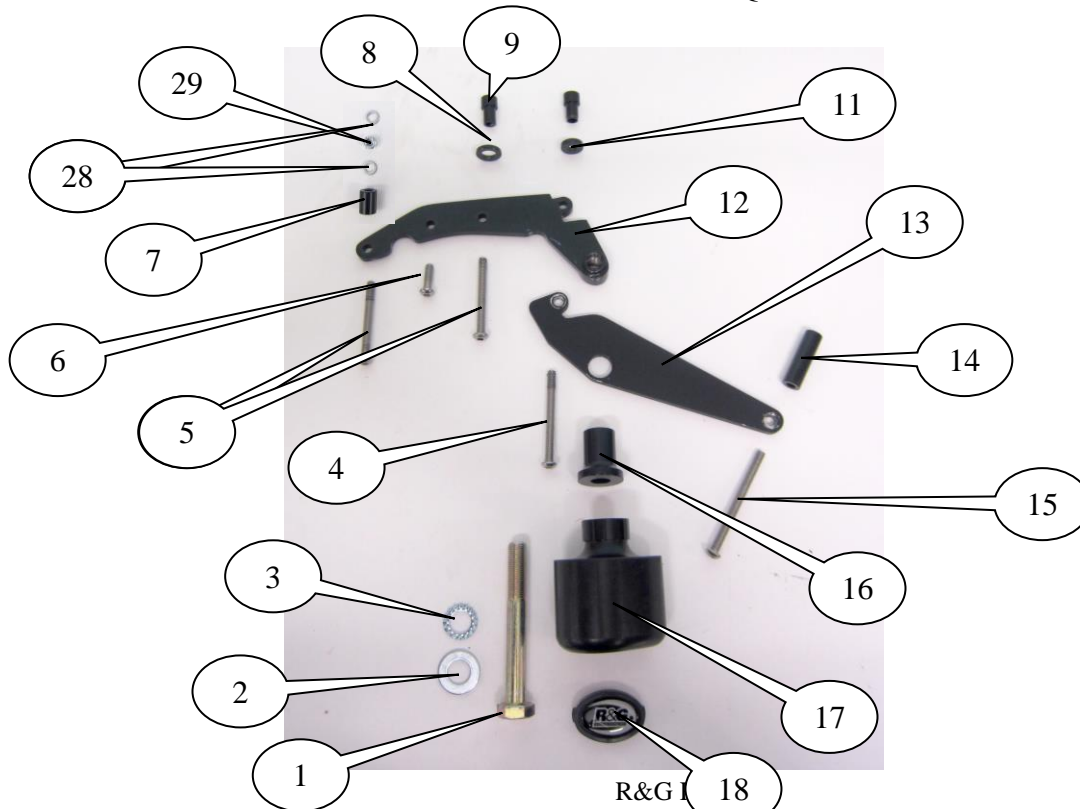

Photo B

LE KIT CONTIENT LES ARTICLES EXPOSES CI-DESSOUS, VERIFIER QUE TOUTES LES PIECES SOIENT PRESENTES AVANT DE PROCEDER AU MONTAGE.

LA FAÇON DONT LE KIT EST EMBALLE NE CORRESPOND PAS FORCEMENT A LA FAÇON DE MONTER LES PIECES SUR LA MOTO.

LES PARTIES PRESENTEES PEUVENT ETRE UNIQUEMENT REPRESENTATIVES (POUR LA CLARTE DES INSTRUCTIONS UNIQUEMENT).



Unit 1, Shelley's Lane, East Worldham, Anton, Hampshire, GU34 3AQ

Tel: +44 (0)1420 89007 Fax: +44 (0)1420 87301 www.rg-racing.com Email: info@rg-racing.com



DROITE

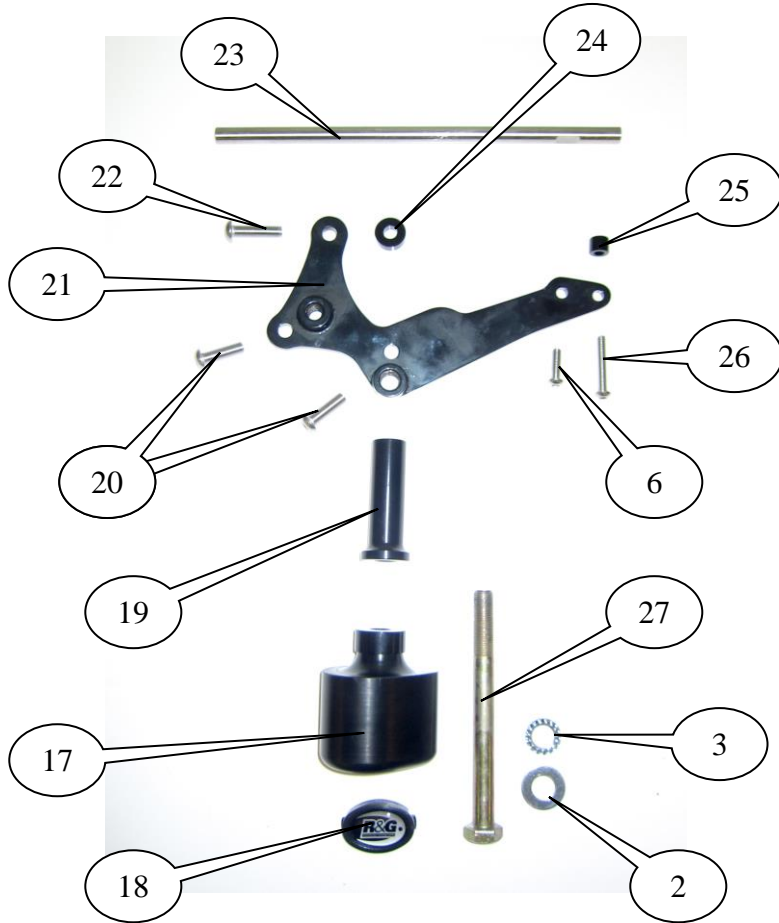

GAUCHE

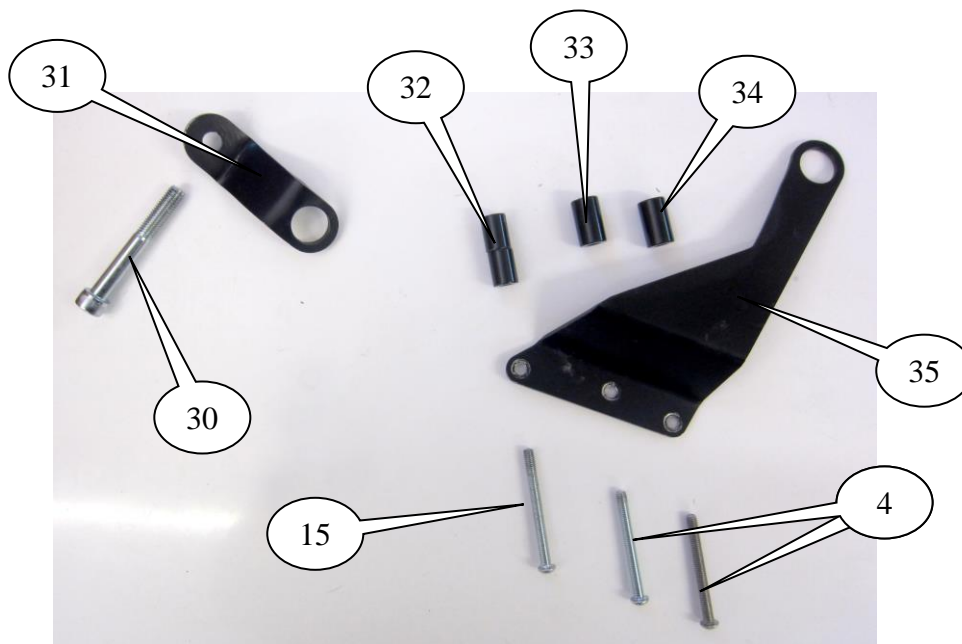

R&G Racing

Unit 1, Shelley's Lane, East Worldham, Alton, Hampshire, GU34 3AQ

Tel: +44 (0)1420 89007 Fax: +44 (0)1420 87301 www.rg-racing.com Email: info@rg-racing.com



BRETELLES DE SOUTIEN

LEGENDE

- ARTICLE 1 = M12x1.25x90mm BOULON (x1).
ARTICLE 2 = M12 RONDELLES (x2).
ARTICLE 3 = RONDELLES DE BLOCAGE (LW0001) (x2).
ARTICLE 4 = M6x65mm BOULONS (x3).
ARTICLE 5 = M6x55mm BOULONS (x2).
ARTICLE 6 = M6x20mm BOULONS (x2).
ARTICLE 7 = ENTRETOISE EN PLASTIC (S0792) (16.5mm de long) (x1).
ARTICLE 8 = ENTRETOISE (S0758) (3mm de long – 9.2mm ID) (x1). *** POUR 1199 '12-'13 UNIQUEMENT ***
ARTICLE 9 = ENTRETOISE (S0737) (23.5mm de long - cranté) (x1).
ARTICLE 10 = ENTRETOISE (S0756) (23.5mm de long – double cranté) (x1).
ARTICLE 11 = ENTRETOISE (S0757) (3mm de long – 8.2mm ID) (x1). *** POUR 1199 '12-'13 & 899 '13- ***
ARTICLE 12 = PLAQUE DE FIXATION ARRIERE DROITE (M0383 Assemblage soudé) (x1).
ARTICLE 13 = PLAQUE DE MONTAGE ARRIERE DROITE (M0384) (x1).
ARTICLE 14 = ENTRETOISE (S0735) (41.5mm de long) (x1).
ARTICLE 15 = M6x70mm BOULON (x2).
ARTICLE 16 = ENTRETOISE (S0739) (31mm de long) (x1).
ARTICLE 17 = PROTECTION CRASH (B0431 avec CS340) (x2).
ARTICLE 18 = CAPUCHONS DE PROTECTION CRASH (BC0002) (x2).
ARTICLE 19 = ENTRETOISE (S0738) (72mm de long) (x1).
ARTICLE 20 = M8x25mm BOULONS (x2).
ARTICLE 21 = PLAQUE DE FIXATION GAUCHE (M0382 Assemblage soudé) (x1).
ARTICLE 22 = M8x30mm BOULON (x1).
ARTICLE 23 = EB077 AXE MOTEUR (252.5mm de long) (x1).
ARTICLE 24 = ENTRETOISE (S0736) (6.5mm de long) (x1).
ARTICLE 25 = ENTRETOISE (S0670) (9mm de long) (x1).
ARTICLE 26 = M6x35mm BOULON (x1).
ARTICLE 27 = M12x1.25x130mm BOULON (x1).
ARTICLE 28 = M6 RONDELLES (x2).
ARTICLE 29 = M6 ECROU (x1).
ARTICLE 30 = BOULON M10 x 1.25 x 50mm DE LONG (GRADE 10.9) (x1).
ARTICLE 31 = PLAQUE DE SOUTIEN GAUCHE (MP0116) (x1).
ARTICLE 32 = ENTRETOISE (S0793) (40mm de long) (x1).
ARTICLE 33 = ENTRETOISE (S0794) (36.5mm de long) (x1).
ARTICLE 34 = ENTRETOISE (S0795) (35mm de long) (x1).
ARTICLE 35 = PLAQUE DE SOUTIEN DROITE (MP0117) (x1).

Notez que si les kits sont emballés avec des rondelles en caoutchouc servant à tenir les composants, ces rondelles doivent être jetées.

OUTILS REQUIS :

- Clés et douilles de 2.5, 3, 4, 5, 6, 7 & 8mm.
- Clés et douille (profonde) de 8mm & 19mm.
 - Clé plate 8 & 10mm.
 - Tournevis plat.
 - Clé dynamométrique (à 40Nm).
- Béquille permettant de supporter la moto lors de l'enlèvement de la suspension arrière.

R&G Racing

Unit 1, Shelley's Lane, East Worldham, Alton, Hampshire, GU34 3AQ

Tel: +44 (0)1420 89007 Fax: +44 (0)1420 87301 www.rg-racing.com Email: info@rg-racing.com



ARRIERE MOTO

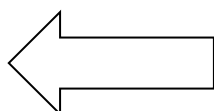

AVANT MOTO

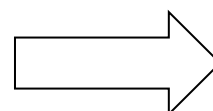

PHOTO C

INSTRUCTIONS DE MONTAGE :

- Enlever les 2 carénages inférieurs de la moto. Pour cela, enlever la lignée de boulons de carénage de chaque coté qui fixent le carénage inférieur au carénage supérieur, avec les boulons de crénage à l'arrière par le pivot du bras oscillant, les 3 boulons sous la moto et les 2 boulons qui sont accessibles à l'intérieur du capot entourant le radiateur inférieur (Photo 1).
- Du coté droit de la moto, le carénage supérieur doit également être enlevé. Enlever les 5 boulons de carénages et le rivet poussoir sur le capot intérieur (*sur la 1299 '15- & 959 '16- ce rivet a été remplacé par un boulon 2.5mm*) avant de tirer doucement le carénage vers l'extérieur, en dehors de son emplacement, voir photo 2.
- **Sur la 959 '16- uniquement** – Pour monter les protections crash, le cache en plastique indiqué sur la photo 3 doit temporairement être extrait de la moto.
- Enlever les 2 boulons qui fixent le cache du carter moteur, voir photo 4.
- Enlever les 2 boulons qui fixent l'avant et l'arrière du cache de l'unité de contrôle ABS, voir photo 5, pour cela utilisez une longue clé Allen ou barre en T, voir photo 6.
- Enlever le cache plastique de la moto, voir photo 7.
- Enlever le clip plastique qui fixe la boîte électronique en place, permettant à cette boîte d'être extraite de la moto, voir photo 8 & 9.
- Enlever les 3 boulons 4mm qui sont à présent accessibles et qui fixent le cache en plastique en place, voir photo 9.
- Une fois ces articles desserrés, ils peuvent être extraits de la zone de travail pour libérer l'accès nécessaire à la prochaine étape, voir photo 10.
- Enlever l'écrou qui fixe l'avant du cache plastique qui est en train d'être enlevé, voir photo 11.
- Enlever les connecteurs de fils de leurs supports plastique en les glissant, voir photo 12.
- L'accès est maintenant possible au boulon du dessous, et peut être enlevé, voir photo 13.
- Enlever les 2 boulons 8mm qui fixent le guide de tuyau plastique en place, voir photo 14.
- Le cache plastique peut maintenant être enlevé de la moto, voir photo 15 mais cela peut être assez difficile. Les 2 supports doivent être levés et éloignés du filetage qui dépasse *des goujons de carter moteur et vers l'avant il y a des guides de tuyaux qui doivent être libérés de leur tuyau. Une fois cela effectué, tirez doucement vers le bas et tordez légèrement vers l'arrière, voir photo 15. Il y a un insert métal sur le support inférieur du cache plastique, faites attention à éviter qu'il touche et marque le carter moteur pendant la manoeuvre.*
- Une fois le cache plastique enlevé, le support de fixation est visible, voir photos 16 & 17.
- Enlever les 2 boulons de carter moteur qui le fixent en place et enlevez le support.
- Remonter les 2 boulons de carter moteur sans le support puis resserrez les boulons aux couples de serrage recommandés.
- Remontez le cache d'unité de contrôle ABS, en utilisant les boulons d'origine, voir photo 18.

R&G Racing

Unit 1, Shelley's Lane, East Worldham, Alton, Hampshire, GU34 3AQ

Tel: +44 (0)1420 89007 Fax: +44 (0)1420 87301 www.rg-racing.com Email: info@rg-racing.com



- **Sur le modèle 1199 '14- uniquement** – Du côté droit de ma moto, enlever les 2 boulons 8mm qui fixent le guide de tuyau plastique en place, voir photo 19.
- Enlever le clip en plastique vissé qui fixe en place le boîtier électronique, ce qui permettra à ce boîtier d'être extrait de la moto, voir photo 20.
- Enlever les 3 boulons 4mm qui sont à présent accessibles et qui fixent le cache en plastique, voir photo 21.
- Enlever les 2 boulons qui fixent le cache de tête de cylindre en place, voir photo 22.
- Une fois ces articles desserrés, ils peuvent être extraits de la zone de travail pour libérer de la place pour les étapes à venir, voir photo 23.
- Sur tous les modèles, enlever les 2 boulons 8mm qui fixent le guide de tuyau flexible en place, voir photo 19, et enlever le boulon 8mm restant qui fixe le guide de tuyau en place à l'avant, voir photo 24. **Pour rendre cela plus facile, enlever les connecteurs de fils de leurs supports plastique en les glissant vers l'extérieur.**
- Cela permettra au guide de tuyau en plastique d'être extrait afin de gagner l'accès nécessaire pour enlever les entretoises et goujons, voir photo 25. **Déclipser le tuyau à l'arrière du plastique vous permettra d'avoir plus de champ pour manoeuvrer le guide de tuyau.**
- Enlever les 2 entretoises puis les goujons en utilisant une clé profonde de 8mm socket, voir photo 26 & 27.
- Prendre l'entretoise crantée (article 9 – S0737 – 23.5mm de long) et insérez la dans le trou le plus en arrière en partant de derrière le guide de tuyau en plastique, voir photo 28.
- Réaliser la même chose pour la double entretoise crantée (article 10 – S0756 – 23.5mm de long) sur le trou restant, voir photo 29.
- Le guide de tuyau en plastique doit à présent reprendre position avec les 2 entretoises alignées avec les trous de boulon dans le carter moteur, voir photo 29.
- **Sur la 1199 '14- la protection cylindre en plastic et les plastics de la boîte électronique peuvent être remis en place, avec le support inférieur de la protection tête de cylindre en plastic placée autour du plus petit cran de l'entretoise S0756 (Photo 29).**
- *Sur la 899 '13- insérez la petite entretoise avec le plus petit diamètre central (Article 11 – S0757 – 3mm de long) autour du plus petit cran visible de l'entretoise S0756, voir photo 30.*
- **Sur la 1199 '12 – '13 insérer la petite entretoise avec le plus petit diamètre central (Article 11 – S0757 – 3mm de long) autour du plus petit cran visible de l'entretoise S0756 et la plus petite entretoise restante (article 8 – S0758 – 3mm de long) autour de la section exposée de l'autre entretoise, S0737.**
- Sur toutes les variantes de modèle, enlever le boulon de carter restant de 8mm, voir photo 31.
- Prenez la plaque de fixation la plus en arrière du côté droit (article 12 – M0383) puis insérez un boulon M6 x 55 de long (article 5) dans le trou le plus en arrière puis dans l'entretoise en plastique (article 7 – S0792 – 16.5mm de long). A présent, insérez une rondelle M6 (article 28), suivi d'un écrou M6 (article 29) puis d'une rondelle M6 (article 28), voir photo 32.
- Serrer l'écrou sur le boulon de façon à ce qu'il commence juste à serrer l'entretoise en plastique.
- A présent, la plaque de fixation la plus en arrière du côté droit avec le boulon vers l'arrière peut être montée sur la moto, voir photo 33.
- Prendre le boulon M6 x 55mm restant (Article 5) et placez le à travers le 3e trou en partant de l'arrière, en le passant à travers les entretoises déjà en place qui fixent l'arrière du guide de tuyau en plastique en place, avant de serrer légèrement dans le carter moteur, voir photo 34.
- Pour vous assurer que le boulon soit correctement monté dans le carter moteur, serrer le boulon dans le carter puis bloquez-le en utilisant l'écrou M6 déjà installé. Cela permettra à l'entretoise en plastique d'être fixée permettra d'absorber les chocs en cas de crash.
- **Sur la 1199 '14- l'ouverture à l'avant de la plaque doit s'adapter au contour plastic (Photo 35).**
- Remettre le boulon avant 8mm pour fixer l'avant du guide de tuyau en place, voir photo 35 et replacer les connecteurs de fils qui ont précédemment été démontés

R&G Racing

Unit 1, Shelley's Lane, East Worldham, Alton, Hampshire, GU34 3AQ

Tel: +44 (0)1420 89007 Fax: +44 (0)1420 87301 www.rg-racing.com Email: info@rg-racing.com



- Enlever le boulon carter moteur depuis l'arrière du tuyau hydraulique, voir photo 36.
- Poser la plaque de fixation avant droite (article 13 – M0384) en place, en veillant à ce que le trou se place autour du filetage de la plaque de montage précédemment installée, avant de placer un boulon M6 x 65mm (Article 4) à travers le trou de supérieur, puis l'autre plaque de montage et les entretoises avant de serrer légèrement dans le carter moteur voir photo 37.
- Prendre la longue entretoise (article 14 – S0735 – 41.5mm de long) et positionnez la entre la plaque de montage et le carter moteur en alignement avec le trou de fixation avant, avant d'insérer le boulon M6 x 70mm (Article 15) et de serrer légèrement, voir photo 38.
- Une fois ces 4 boulons de fixation en place et les plaques de fixation correctement montées, serrer les boulons aux couples de serrage recommandés, voir photo 39.

- **Sur la 1199 '14- uniquement** – veiller à ce que le boîtier électronique en plastique soit correctement placée avant de remettre les 3 boulons qui la fixent en place, voir photo 40. Remettre le boîtier électronique en place avec le petit clip plastique et le boulon, avant de serrer. Remettre également les 2 boulons qui fixent la protection tête de cylindre en plastique en place.

- Du côté gauche de la moto, insérer l'axe moteur (article 23 – EB077 – 252.5mm de long) derrière le cylindre arrière, permettant à l'autre extrémité de se placer avec le trou restant du côté droit de la plaque de fixation. *Note : Insérer l'axe moteur de façon à ce que l'extrémité avec la clé plate 8mm se place du côté gauche de la moto, voir photo 41.* Insérer un boulon M6 x 20mm (article 6) à travers la plaque de fixation et serrer légèrement dans l'axe moteur.
- La photo 42 montre ce à quoi ressemble l'assemblage monté sur une Panigale 1199 '14-.
- La photo 43 montre ce à quoi ressemble l'assemblage monté sur une Panigale 899 '13-.
- La moto doit être montée sur la béquille qui supporte la moto au niveau du bras oscillant pour permettre à la suspension arrière d'être enlevée (Photo 44). La roue arrière devra également être supportée pour empêcher qu'elle ne roule lorsque l'absorbeur de choc sera enlevé.
- Enlever le petit cache plastic qui se fixe à l'avant du support absorbeur de choc avant, avant d'enlever les 2 boulons qui fixent l'absorbeur de choc en place, voir photo 45.
- Une fois l'absorbeur de choc enlevé, enlever les 3 boulons qui fixent la plaque de montage avant en place à la tête de cylindre arrière, voir photo 46.
- Enlever le boulon de carter moteur qui se place à côté de l'axe moteur précédemment installé et au dessus de la liaison de l'amortisseur arrière, voir photo 47.
- Prendre la plaque de montage côté gauche (article 21 – M0382) et montez la sur la moto, voir photo 48. Insérer un boulon M8 x 25mm (article 20) dans le trou avant de la plaque de fixation et dans le trou fileté du côté de la tête de cylindre, également indiqué sur la photo 48.
- Sur le trou de fixation supérieur, placer le boulon M8 x 30mm (article 22) dans la plaque de fixation, puis à travers l'entretoise courte (article 24 – S0736 – 6.5mm de long) puis serrer légèrement dans le trou fileté du côté de la tête de cylindre, voir photo 49.
- Insérer le boulon restant M8 x 25mm (article 20) dans le dernier des 3 trous de fixation restants, au dessus du trou fileté.
- A l'arrière de la plaque de fixation, insérer un boulon M6 x 35mm (article 26) dans le trou de la plaque de fixation, puis à travers la petite entretoise (article 25 – S0670 – 9mm de long) avant de serrer légèrement dans le carter moteur, voir photo 50.
- L'axe moteur précédemment installé doit à présent être en place en s'alignant avec le trou restant de la plaque de fixation. Insérer le boulon restant M6 x 20mm (article 6) et serrer légèrement dans l'axe moteur, voir photo 50.
- Une fois la plaque de fixation correctement montée, l'ensemble doit ressembler à la photo 51. Serrer tous les boulons aux couples de serrage recommandés. Pour le boulon qui est serré dans l'axe moteur, tenir l'axe

R&G Racing

Unit 1, Shelley's Lane, East Worldham, Alton, Hampshire, GU34 3AQ

Tel: +44 (0)1420 89007 Fax: +44 (0)1420 87301 www.rg-racing.com Email: info@rg-racing.com



moteur en place en utilisant une clé 8mm, tout en serrant le boulon, voir photo 41. *Veiller à bien serrer le boulon de l'autre extrémité de l'axe moteur également.*

- Remonter l'absorbeur de choc sur la moto à l'aide du boulon d'origine sur le support arrière mais en utilisant le boulon M10 x 1.25 x 50mm de long - grade 10.9 fourni dans le kit (article 30) sur le support avant. Une fois installé, placez le en 1er à travers l'entretoise d'origine creusée puis à travers le plus petit trou de la plaque de soutien du côté gauche (article 31 – MP0116) de façon à ce que le coude dans la plaque s'extrait de la moto, voir photos 52 & 53. Serrer légèrement, *de façon à ce que la plaque de soutien puisse être bougée.*
- La protection crash peut à présent être installée. Glisser une des rondelles 12mm (article 2) sur le boulon M12 x 1.25 x 130mm (article 27) pour que la rondelle soit contre la tête du boulon.
- Glisser une des rondelles de blocage (Article 3) autour du boulon de façon à ce qu'elle se place contre la rondelle tout juste installée.
- Glisser ensuite le boulon avec rondelles à travers la protection crash (article 17) pour que la tête du boulon et les rondelles aillent dans le contre alésage de la bobine.
- Placer la plus longue entretoise de protection crash (Article 19 – S0738 – 72mm de long) autour de l'extrémité du boulon, en veillant à ce que le diamètre le plus large soit contre la protection crash, voir photo 54.
- Monter la protection sur la plaque de fixation en plaçant l'entretoise à travers le trou plus large dans la plaque de soutien du côté gauche puis serrer le boulon dans la plaque de fixation principale, voir photo 55, en faisant attention à ce que le fil passe au dessus de l'entretoise.
- Serrer le boulon de la protection jusqu'à ce que vous sentiez une compression de l'intérieur de la protection avec une clé de 19mm, voir photo 56. **LA PROTECTION DOIT ETRE POSITIONNEE COMME EN "C" AVEC LE COTE ARRONDI LE PLUS GROS EN DIRECTION DE L'AVANT DE LA MOTO.** Tourner un peu plus afin d'accentuer légèrement la compression. Faire un quart de tour. Pas plus de 40 Nm de couple - Ne pas trop serrer, au risque d'abîmer les composants.
- Serrer la vis de choc avant. Ne pas excéder 40Nm de couple.
- Du côté droit de la moto, enlever les 3 boulons M6 qui fixent le carter inférieur (photo 57).
- Prendre la plaque de soutien côté droit (article 35 – MP0117) et posez là sur la moto, (voir photo 58).
- Insérez 2 boulons M6 x 65mm (article 4) à travers les 2 trous avant au bas de la plaque et le boulon restant M6 x 70mm (article 15) dans le trou arrière restant, voir photo 59.
- A l'arrière de la plaque, placer une entretoise de 40mm (article 32 – S0793 – 40mm de long) autour du filetage exposé du boulon, l'entretoise 36.5mm (article 33 – S0794 – 36.5mm de long) autour du boulon central et l'entretoise 35mm (article 34 – S0795 – 35mm de long) autour du boulon avant, voir photo 59.
- A présent, la plaque de soutien doit être correctement fixée dans sa position, voir photo 58.
- Glisser une des rondelles 12mm (Article 2) sur le boulon M12 x 1.25 x 90mm (article 1) de façon à ce que la rondelle se place contre la tête du boulon
- Glisser une rondelle de blocage (article 3) autour du boulon pour qu'elle se place contre la rondelle tout juste installée.
- Glisser ensuite le boulon avec ses rondelles dans la protection crash restant (article 17) pour que la tête du boulon et les rondelles aillent dans le contre alésage de la bobine.
- Placer la plus longue entretoise de protection crash (article 16 – S0739 – 31mm de long) autour de l'extrémité du boulon, en veillant à ce que le diamètre le plus large soit contre la protection crash (Photo 60).
- Placer la protection crash et l'entretoise dans le trou supérieur de la plaque de soutien et serrer le boulon dans la plaque de fixation principale, voir photo 61.
- Serrer le boulon de la protection jusqu'à ce que vous sentiez une compression de l'intérieur de la protection avec une clé de 19mm. **LA PROTECTION DOIT ETRE POSITIONNEE COMME EN "C" AVEC LE COTE ARRONDI LE PLUS GROS EN DIRECTION DE L'AVANT DE LA MOTO.** Tourner un peu plus afin d'accentuer légèrement la compression. Faire un quart de tour. Pas plus de 40 Nm de couple - Ne pas trop serrer, au risque d'abîmer les composants.
- Remette le petit cache plastic pour l'amortisseur arrière sur le côté gauche de la moto.

R&G Racing

Unit 1, Shelley's Lane, East Worldham, Alton, Hampshire, GU34 3AQ

Tel: +44 (0)1420 89007 Fax: +44 (0)1420 87301 www.rg-racing.com Email: info@rg-racing.com



- Remettre le carénage supérieur du coté droit et les carénages inférieurs des 2 cotés de la moto , voir photos 62 & 63.
- Veiller à ce que les carénages soient correctement montés avec tous les boulons complètement serrés.
- Si cela n'est pas déjà fait, appliquez les stickers en caoutchouc dans le creux des 2 capuchons de protection crash..
- Insérez les capuchons dans les 2 protections crash.

ISSUE 2 26/01/2016 (AR)

CONSUMER NOTICE

The catalogue description and any exhibition of samples are only broad indications of the Products and R&G may make design changes which do not diminish their performance or visual appeal and supplying them in such state shall conform to the order. The Buyer acknowledges no representation or warranty (other than as to title) has been given or will apply to the Products other than those in R&G's order or confirmation and the Buyer confirms it has chosen the Products as being of merchantable quality and suitable for its particular purposes. Where R&G fits the Products or undertakes other services it shall exercise reasonable skill and care and rectify any fault free of charge unless the workmanship has been disturbed. The Buyer is responsible for ensuring that the warranty on the motorcycle is not affected by the fitting of the Products. On return of any defective Products R&G shall at its option either supply a replacement or refund the purchase money but shall not be liable if the Products have been modified or used or maintained otherwise than in accordance with R&G's or manufacturer's instructions and good engineering practice or if the defect arises from accident or neglect. Other than identified above and subject to R&G not limiting its liability for causing death and personal injury, it shall not be liable for indirect or consequential loss and otherwise its liability shall be limited to the amounts paid by the Buyer for the Products or the fitting or service concerned. These terms do not affect the Buyer's statutory rights.

R&G RACING RETURNS POLICY (NON-FAULTY GOODS)

Returns must be pre-authorised (if not pre-authorised the return will be rejected). Goods may only be returned direct to us if they were purchased direct from us (customer must prove if necessary). Otherwise to be returned to original vendor. Goods must be in re-sellable condition, in the opinion of R&G Racing. All returns are subject to a 25% restocking and handling fee (25% of the gross value exc. P&P – at the prevailing price at time of purchase). The customer must pay any and all carriage charges. No returns of discontinued products, unless within 14 days of purchase. This policy does not affect your statutory rights and does not refer to faulty goods.

R&G Racing

Unit 1, Shelley's Lane, East Worldham, Alton, Hampshire, GU34 3AQ

Tel: +44 (0)1420 89007 Fax: +44 (0)1420 87301 www.rg-racing.com Email: info@rg-racing.com