



FITTING INSTRUCTIONS FOR CP0421BL
AERO CRASH PROTECTORS
SUZUKI GSX-R1000 '17- DRILL KIT

Page | 1



Picture A



Picture B

THIS KIT CONTAINS THE ITEMS PICTURED AND LABELLED BELOW.
DO NOT PROCEED UNTIL YOU ARE SURE ALL PARTS ARE PRESENT.

Please note that the way the kit is packed does not necessarily represent the way of mounting to the bike.

THE PARTS SHOWN MAY BE REPRESENTATIVE ONLY (FOR CLARITY OF INSTRUCTIONS ONLY).

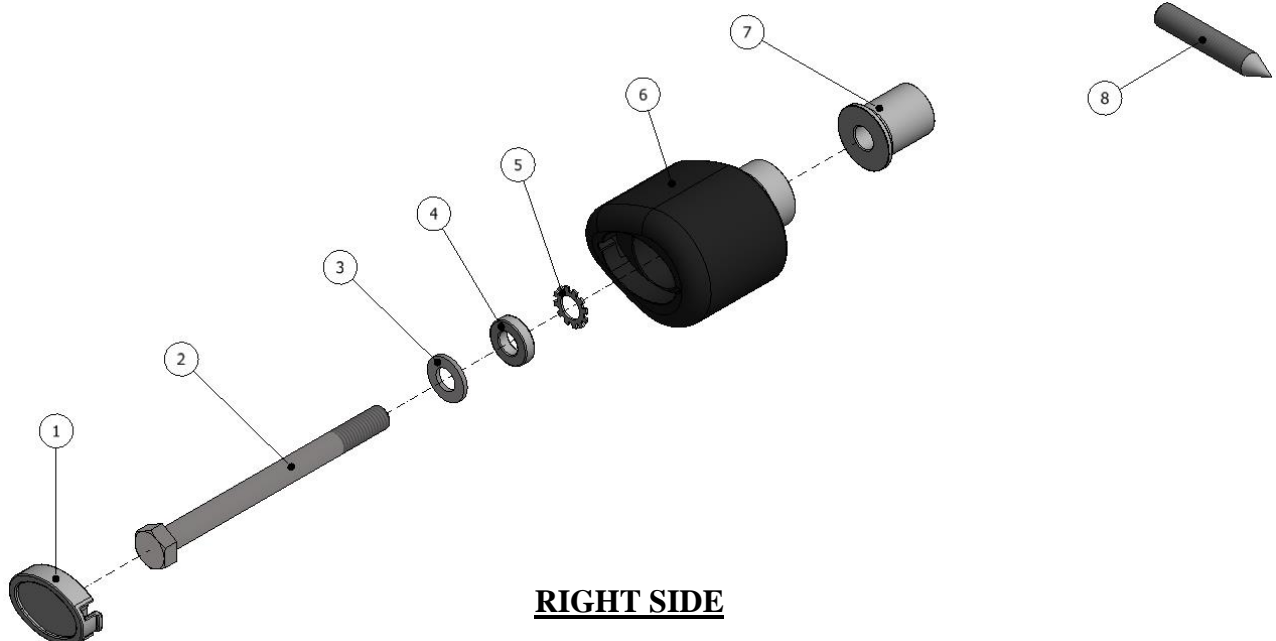

RIGHT SIDE

R&G Racing
 Unit 1, Shelley's Lane, East Worldham, Alton, Hampshire, GU34 3AQ
 Tel: +44 (0)1420 89007 Fax: +44 (0)1420 87301 www.rg-racing.com Email: info@rg-racing.com

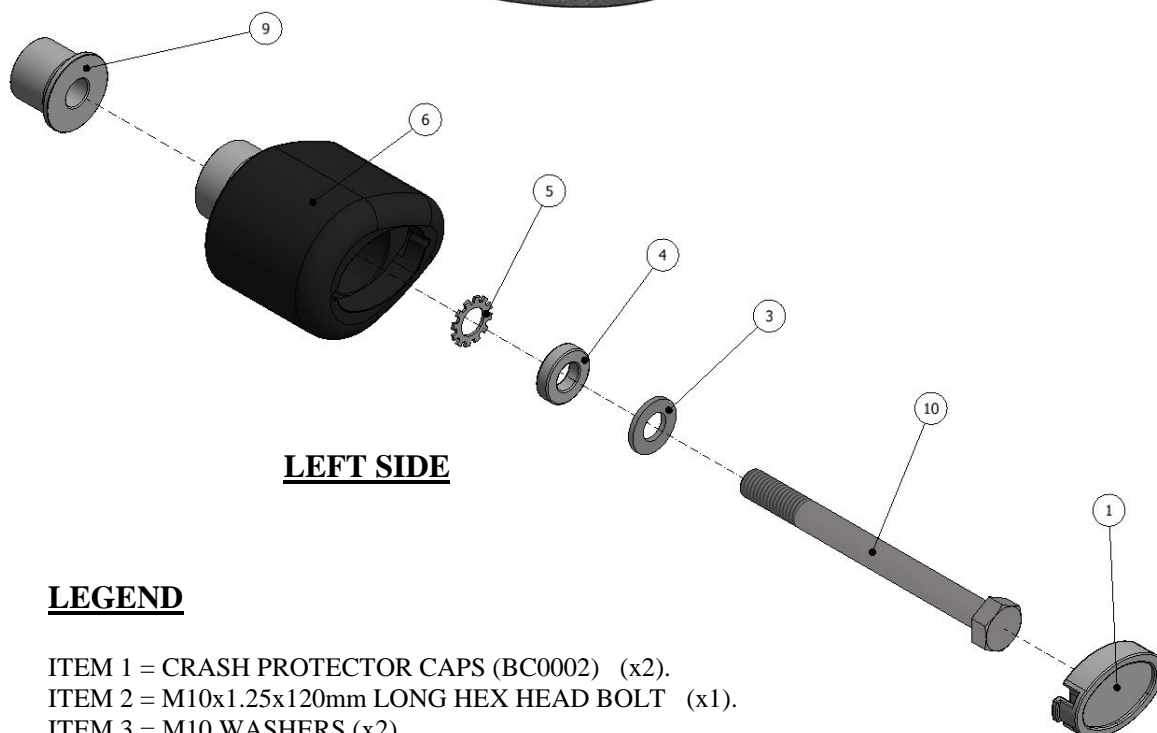
**LEFT SIDE****LEGEND**

- ITEM 1 = CRASH PROTECTOR CAPS (BC0002) (x2).
 ITEM 2 = M10x1.25x120mm LONG HEX HEAD BOLT (x1).
 ITEM 3 = M10 WASHERS (x2).
 ITEM 4 = SPACER (S0293) (5mm LONG) (x2).
 ITEM 5 = LOCK-WASHERS (LW0001) (x2).
 ITEM 6 = CRASH PROTECTOR (B0431 with CS341) (x2).
 ITEM 7 = SPACER (S1020) (28mm LONG) (x1).
 ITEM 8 = MARKING TOOL (T0011) (x1).
 ITEM 9 = SPACER (S1019) (20mm LONG) (x1).
 ITEM 10 = M10x1.25x110mm LONG HEX HEAD BOLT (x1).

Please note that in cases where kits are packed with rubber washers holding the components onto the bolt – *the rubber washers should be thrown away!*

TOOLS REQUIRED

- Socket set to include 4, 5 & 8mm A/F socket and wrench.
 - Socket set to include 17mm socket and wrench.
 - Flat head screwdriver.
- 28mm Hole-saw and/or dremmel type tool.
 - Torque wrench (up to 40N/m).

TOWARDS REAR
OF BIKE

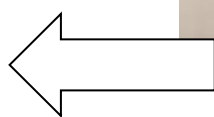

TOWARDS FRONT
OF BIKE

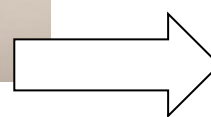

PICTURE C

R&G Racing

Unit 1, Shelley's Lane, East Worldham, Alton, Hampshire, GU34 3AQ

Tel: +44 (0)1420 89007 Fax: +44 (0)1420 87301 www.rg-racing.com Email: info@rg-racing.com



GENERAL TORQUE SETTINGS

M4 BOLT = 8Nm

M5 BOLT = 12Nm

M6 BOLT = 15Nm

M8 BOLT = 20Nm

M10 BOLT = 40Nm

M12 NYLOC NUT = 40Nm

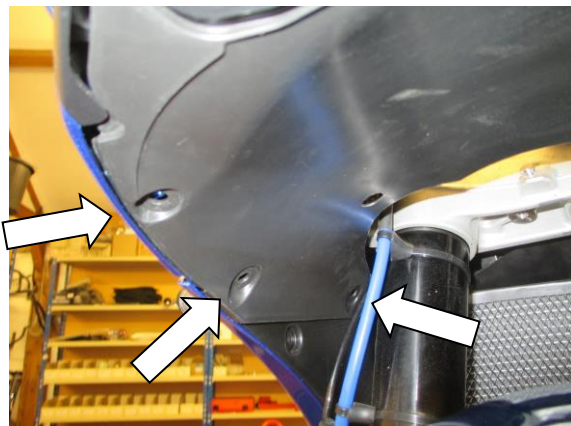

Picture 1



Picture 2



Picture 3



Picture 4

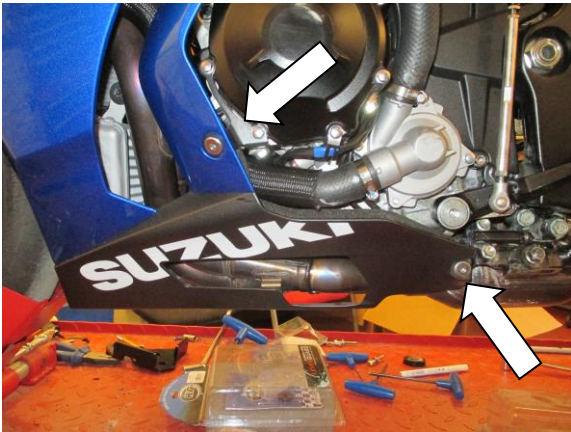

Picture 5



Picture 6



Picture 7



Picture 8



Picture 9



Picture 10

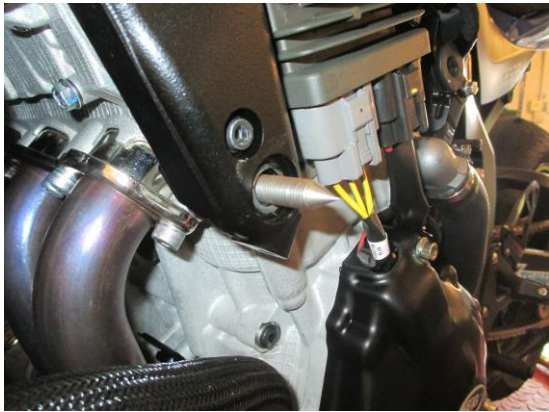

Picture 11

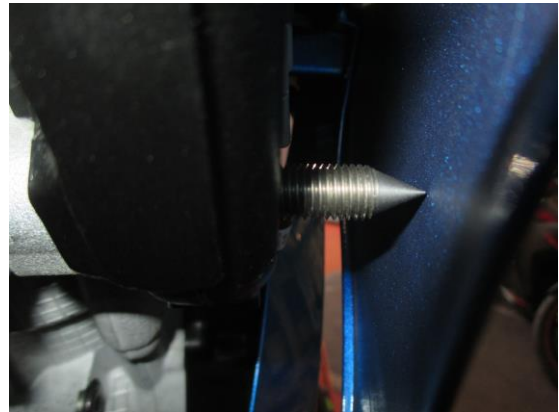

Picture 12



Picture 13



Picture 14



Picture 15



Picture 16



Picture 17



Picture 18

FITTING INSTRUCTIONS

- To fit the crash protectors, the fairings must first be removed from the motorcycle.
- Remove the under-nose plastic cowl, by removing the six push rivets arrowed in pictures 1 & 2 and the remaining two push rivets in the centre, as shown in picture 3.
- To remove the left side fairing, remove the four bolts that are arrowed in pictures 4 & 5 and the push rivet that mounts the radiator cowl that is shown in picture 6.
- The left side fairing can now be removed from the bike. Start by pulling the rear off its rubber mount, as shown in picture 7, before removing the top edge from its rubber mount and plastic locating tabs, as shown in picture 8. With the top edge released, disconnect the wiring connector for the indicator, as shown in picture 9 then unclip the mounts along the front bottom edge that mount the bellypan to the radiator surround. The fairing should then be free to be removed from the bike.
- Repeat the above two steps to remove the fairing from the right side of the bike. *The push rivet that secures the radiator surround on the right side can be left in place as this can remain fixed to the fairing.*
- On the left side of the bike, remove the engine bolt that is shown in picture 10 and insert the marking tool (item 8 – T0011) into the boss so that the point on the end sits roughly against where the fairing panel sits when refitted to the motorcycle, as shown in picture 11.
- Re-fit the fairing panel to the motorcycle and gently press the panel in towards the marking tool to leave an impression on the panel. Remove the fairing from the motorcycle and there will be a mark on the inside. Using a 28mm holesaw cutter, very carefully drill a pilot hole on the marked point (only drill pilot hole), as shown in picture 12.
- Re-fit the fairing to the motorcycle, ensuring that the marking tool is positioned within the centre of the drilled hole. Once happy, carefully open the hole using the 28mm hole saw cutter, as shown in picture 13. Debur the hole using a sharp knife or emery paper taking care not to mark the outside of the fairing.
- Remove the marking tool.
- Re-fit the fairing to the motorcycle as shown in picture 14.
- Ensure the fairing is correctly positioned on all its mounting points before following the reverse procedure of removal to re-fit all the mounting bolts.
- The crash protector can now be fitted. Slide one of the 10mm washers (item 3) onto the longer M10 x 1.25 x 120mm long hex head bolt (item 2) so the washer sits against head of bolt.
- Slide one of the small spacers (item 4 – S0293 – 5mm long) over the bolt so it sits against the washer just fitted.
- Slide one serrated locking washer (item 5) over the bolt so it sits against the spacer just fitted.

R&G Racing

Unit 1, Shelley's Lane, East Worldham, Alton, Hampshire, GU34 3AQ

Tel: +44 (0)1420 89007 Fax: +44 (0)1420 87301 www.rg-racing.com Email: info@rg-racing.com



- Next slide the bolt with washers through either crash protector (item 6) so the head of the bolt and washers go into the counter-bore of the bobbin.
- Locate the longer spacer (item 7 – S1020 – 28mm long) over the exposed thread and position this through the hole in the fairing and tighten into the boss on the frame, as shown in picture 15.
- Tighten the crash protector bolt until you feel some compression from inside the protector using a 17mm socket and wrench. **PLEASE NOTE THE CRASH PROTECTOR MUST BE POSITIONED AS IN PICTURE ‘C’ WITH BIGGER END TOWARD FRONT OF BIKE.** Turn a little more so that you feel the compression increase slightly. Then apply a quarter turn. Do not over tighten as damage can occur to the bike. Do not exceed 40N/m of torque.
- On the right side of the bike, remove the engine bolt and insert the marking tool (item 8 – T0011) into the boss so that the point on the end sits roughly against where the fairing panel sits when refitted to the motorcycle, as shown in picture 16.
- Re-fit the fairing panel to the motorcycle and gently press the panel in towards the marking tool to leave an impression on the panel. Remove the fairing from the motorcycle and there will be a mark on the inside. Using a 28mm holesaw cutter, very carefully drill a pilot hole on the marked point (only drill pilot hole).
- Re-fit the fairing to the motorcycle, ensuring that the marking tool is positioned within the centre of the drilled hole. Once happy, carefully open the hole using the 28mm hole saw cutter, as shown in picture 17. Debur the hole using a sharp knife or emery paper taking care not to mark the outside of the fairing.
- Remove the marking tool.
- Re-fit the fairing to the motorcycle in the reverse procedure of removal to re-fit all the mounting bolts.
- The crash protector can now be fitted. Slide one of the 10mm washers (item 3) onto the remaining shorter M10 x 1.25 x 110mm long hex head bolts (item 10) so the washer sits against head of bolt.
- Slide one of the small spacers (item 4 – S0293 – 5mm long) over the bolt so it sits against the washer just fitted.
- Slide one serrated locking washer (item 5) over the bolt so it sits against the spacer just fitted.
- Next slide the bolt with washers through either crash protector (item 6) so the head of the bolt and washers go into the counter-bore of the bobbin.
- Locate the shorter spacer (item 9 – S1019 – 20mm long) over the exposed thread and position this through the hole in the fairing and tighten into the boss on the frame, as shown in picture 18.
- Tighten the crash protector bolt until you feel some compression from inside the protector using a 17mm socket and wrench. **PLEASE NOTE THE CRASH PROTECTOR MUST BE POSITIONED AS IN PICTURE ‘C’ WITH BIGGER END TOWARD FRONT OF BIKE.** Turn a little more so that you feel the compression increase slightly. Then apply a quarter turn. Do not over tighten as damage can occur to the bike. Do not exceed 40N/m of torque.
- Ensure the fairing is secure and correctly fitted, and that the indicators have been re-connected and are working correctly.
- If not already fitted fit bubble stickers into recess of both crash protector caps.
- Fit crash protector caps into both crash protectors.

ISSUE 1 11/05/2017 (AR)

Digital copies of these instructions are available to download from www.rg-racing.com



CONSUMER NOTICE

The catalogue description and any exhibition of samples are only broad indications of the Products and R&G may make design changes which do not diminish their performance or visual appeal and supplying them in such state shall conform to the order. The Buyer acknowledges no representation or warranty (other than as to title) has been given or will apply to the Products other than those in R&G's order or confirmation and the Buyer confirms it has chosen the Products as being of merchantable quality and suitable for its particular purposes. Where R&G fits the Products or undertakes other services it shall exercise reasonable skill and care and rectify any fault free of charge unless the workmanship has been disturbed. The Buyer is responsible for ensuring that the warranty on the motorcycle is not affected by the fitting of the Products. On return of any defective Products R&G shall at its option either supply a replacement or refund the purchase money but shall not be liable if the Products have been modified or used or maintained otherwise than in accordance with R&G's or manufacturer's instructions and good engineering practice or if the defect arises from accident or neglect. Other than identified above and subject to R&G not limiting its liability for causing death and personal injury, it shall not be liable for indirect or consequential loss and otherwise its liability shall be limited to the amounts paid by the Buyer for the Products or the fitting or service concerned. These terms do not affect the Buyer's statutory rights.

R&G RACING RETURNS POLICY (NON-FAULTY GOODS)

Returns must be pre-authorized (if not pre-authorized the return will be rejected). Goods may only be returned direct to us if they were purchased direct from us (customer must prove if necessary). Otherwise to be returned to original vendor. Goods must be in re-sellable condition, in the opinion of R&G Racing. All returns are subject to a 25% restocking and handling fee (25% of the gross value exc. P&P – at the prevailing price at time of purchase). The customer must pay any and all carriage charges. No returns of discontinued products, unless within 14 days of purchase. This policy does not affect your statutory rights and does not refer to faulty goods.



NOTICE DE MONTAGE POUR CP0421BL
PROTECTIONS CRASH
SUZUKI GSX-R1000 '17- KIT PERCE

Page | 9



Photo A

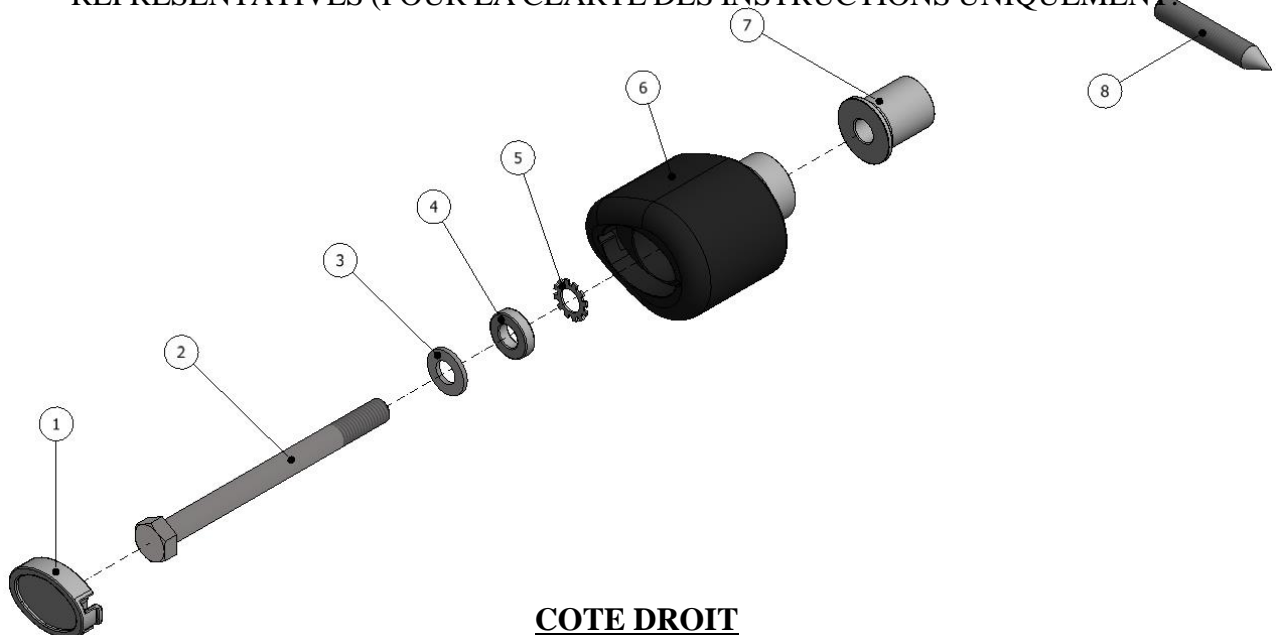

Photo B

LE KIT CONTIENT LES ARTICLES EXPOSES CI-DESSOUS, VERIFIER QUE TOUTES LES PIECES SOIENT PRESENTES AVANT DE PROCEDER AU MONTAGE.

LA FAÇON DONT LE KIT EST EMBALLE NE CORRESPOND PAS FORCEMENT A LA FAÇON DE MONTER LES PIECES SUR LA MOTO.

LES PARTIES PRESENTEES PEUVENT ETRE UNIQUEMENT REPRESENTATIVES (POUR LA CLARTE DES INSTRUCTIONS UNIQUEMENT)



COTE DROIT

Unit 1, Shelley's Lane, East Worldham, Alton, Hampshire, GU34 3AQ
 Tel: +44 (0)1420 89007 Fax: +44 (0)1420 87301 www.rg-racing.com Email: info@rg-racing.com

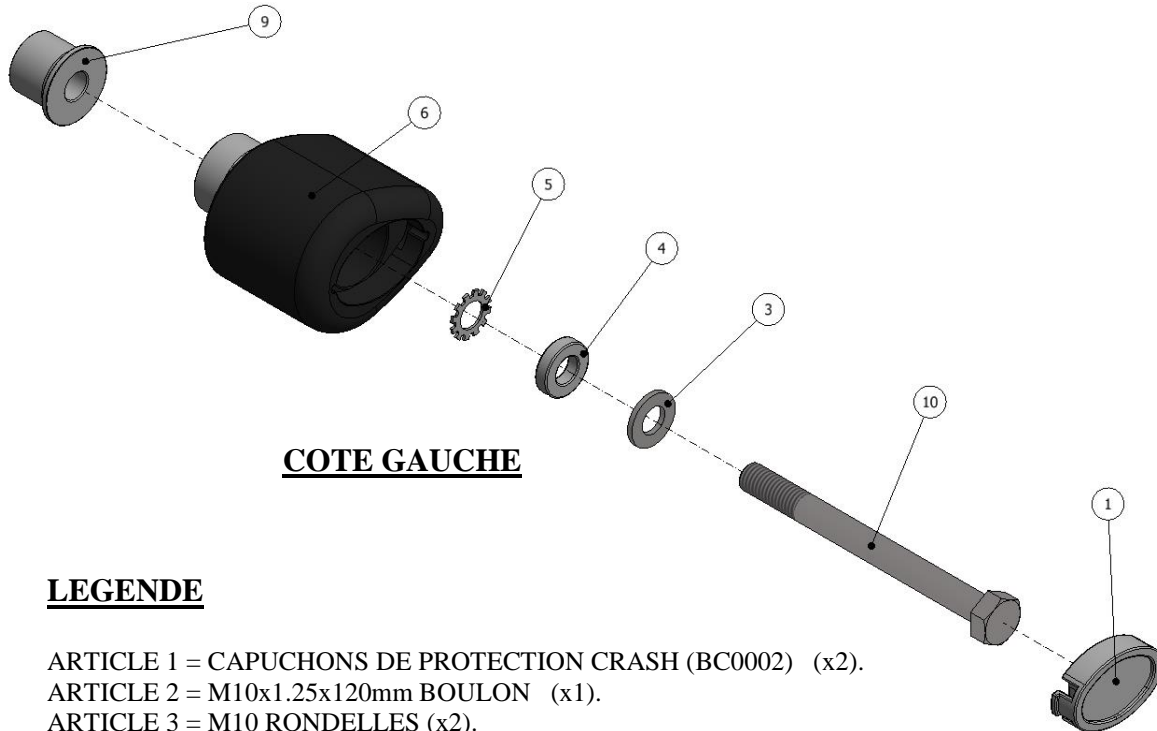

COTE GAUCHE

LEGENDE

- ARTICLE 1 = CAPUCHONS DE PROTECTION CRASH (BC0002) (x2).
 ARTICLE 2 = M10x1.25x120mm BOULON (x1).
 ARTICLE 3 = M10 RONDELLES (x2).
 ARTICLE 4 = ENTRETOISE (S0293) (5mm DE LONG) (x2).
 ARTICLE 5 = RONDELLES DE BLOCAGE (LW0001) (x2).
 ARTICLE 6 = PROTECTION CRASH (B0431 avec CS341) (x2).
 ARTICLE 7 = ENTRETOISE (S1020) (28mm DE LONG) (x1).
 ARTICLE 8 = OUTIL DE MARQUAGE (T0011) (x1).
 ARTICLE 9 = ENTRETOISE (S1019) (20mm DE LONG) (x1).
 ARTICLE 10 = M10x1.25x110mm BOULON (x1).

Notez que si les kits sont emballés avec des rondelles en caoutchouc servant à tenir les composants sur le boulon, *ces rondelles doivent être jetées!*

OUTILS REQUIS

- Clé et douilles 4, 5 & 8mm.
 - Clé 17mm.
 - Tournevis plat.
 - Scie trou 28mm.
- Clé dynamométrique (à 40Nm).

ARRIERE MOTO



AVANT MOTO

R&G Racing

Unit 1, Shelley's Lane, East Worldham, Alton, Hampshire, GU34 3AQ

Tel: +44 (0)1420 89007 Fax: +44 (0)1420 87301 www.rg-racing.com Email: info@rg-racing.com



PHOTO C

COUPLES DE SERRAGE RECOMMANDES

M4 BOULON = 8Nm
 M5 BOULON = 12Nm
 M6 BOULON = 15Nm
 M8 BOULON = 20Nm
 M10 BOULON = 40Nm
 M12 ECROU = 40Nm

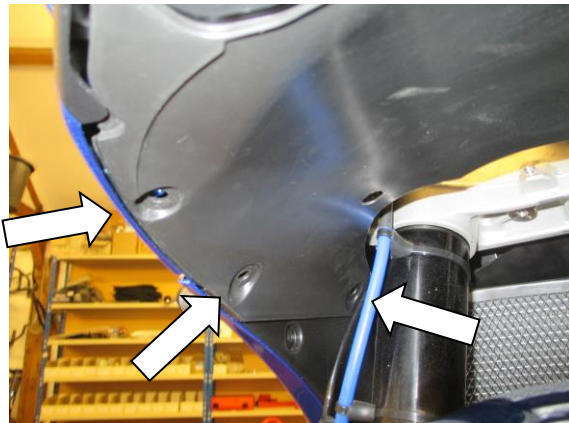

Photo 1



Photo 2



Photo 3



Photo 4

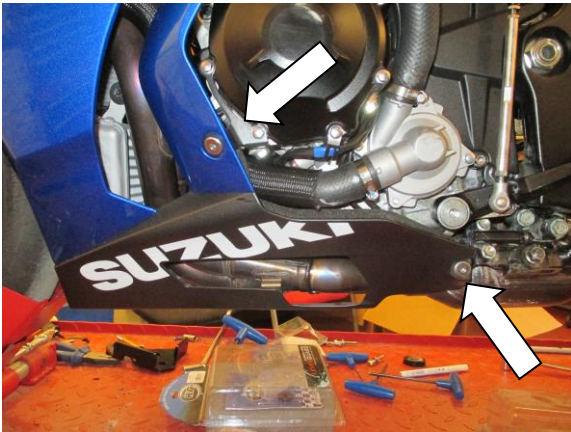

Photo 5



Photo 6



Photo 7



Photo 8



Photo 9



Photo 10

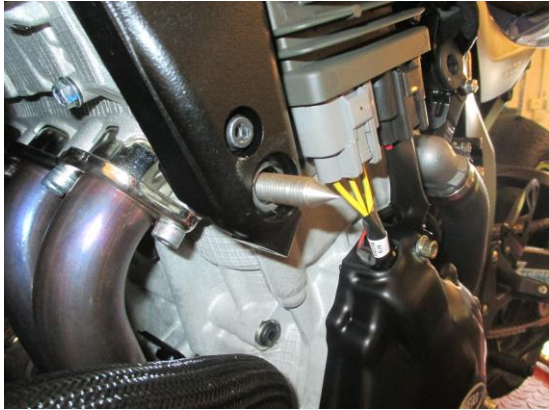

Photo 11

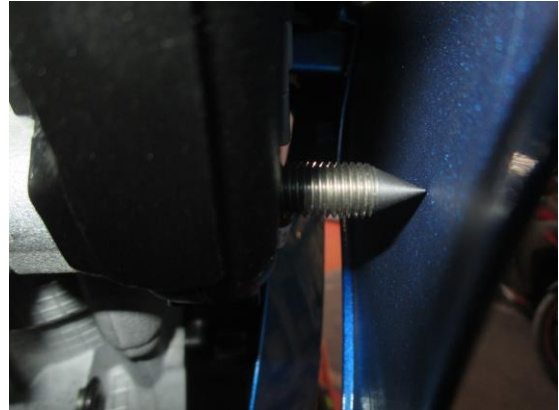

Photo 12



Photo 13



Photo 14



Photo 15



Photo 16



Photo 17



Photo 18

NOTICE DE MONTAGE :

- Pour monter les protections, les carénages doivent être enlevés de la moto.
- Enlever le capot de sous-nez en plastique, en enlevant les 6 rivets indiqués sur les photos 1 & 2 et les 2 rivets restants au centre, voir photo 3.
- Pour enlever le carénage coté gauche, enlever les 4 boulons indiqués sur les photos 4 & 5 et le rivet qui fixe le capot de radiateur indiqué sur la photo 6.
- Le carénage gauche peut à présent être enlevé de la moto. Commencez par tirer l'arrière de son support en caoutchouc, voir photo 7, avant d'enlever le bord supérieur de son support en caoutchouc et les onglets de fixation plastique, voir photo 8. Une fois le bord supérieur libéré, déconnecter le connecteur de fil de clignotant, voir photo 9 puis déclipser les supports le long du bord inférieur avant qui fixe le ventre au contour de radiateur. Le carénage doit maintenant pouvoir s'enlever de la moto.
- Répéter les 2 étapes supérieures pour enlever le carénage du coté droit de la moto. *Le rivet qui fixe le contour de radiateur du coté droit peut rester en place, car il rester fixé au carénage.*
- Du coté gauche de la moto, enlever le boulon moteur indiqué sur la photo 10 et insérer l'outil de marquage (article 8 – T0011) dans le trou pour que le point à l'extrémité se place à l'endroit où le panneau de carénage doit se placer sur la moto, voir photo 11.
- Remonter le panneau de carénage sur la moto et presser légèrement le panneau vers l'outil de marquage pour laisser une marque sur le panneau. Enlever le carénage de la moto, il doit y avoir une marque à l'intérieur. En utilisant une scie-trou 28mm, percer un trou pilote sur la marque (seulement un trou pilote), voir photo 12.
- Remonter le carénage sur la moto, en veillant à ce que l'outil de marquage soit positionné au centre du trou pilote. Une fois satisfait, ouvrir le trou à l'aide d'une scie trou de 28mm, voir photo 13. Ebarber le trou en utilisant un knife aiguisé ou du papier Emery en faisant attention à ne pas marquer l'extérieur du carénage.
- Enlever l'outil de marquage.
- Remonter le carénage sur la moto, voir photo 14.
- Veiller à ce que le carénage soit correctement positionné sur tous ces points de fixation avant d'effectuer la procédure inverse du démontage pour remettre tous les boulons de fixation.

R&G Racing

Unit 1, Shelley's Lane, East Worldham, Alton, Hampshire, GU34 3AQ

Tel: +44 (0)1420 89007 Fax: +44 (0)1420 87301 www.rg-racing.com Email: info@rg-racing.com



- La protection crash peut maintenant être montée. Glisser une des rondelles 10mm (article 3) sur le boulon M10 x 1.25 x 120mm (article 2) de façon à ce que la rondelle se place contre le boulon.
- Glisser une des petites entretoises (article 4 – S0293 – 5mm de long) sur le boulon pour qu’il se place contre la rondelle tout juste insérée.
- Glisser une rondelle de blocage (article 5) sur le boulon pour qu’il se place contre l’entretoise tout juste insérée.
- Glisser ensuite le boulon avec rondelles dans la protection crash (article 6) pour que la tête du boulon et les rondelles se placent dans le contre alésage de la bobine.
- Placer l’entretoise (article 7 – S1020 – 28mm de long) sur le filetage et positionnez le dans le trou du carénage puis serrer dans le trou du cadre, voir photo 15.
- Serrer le boulon de la protection jusqu’à ce que vous sentiez une compression de l’intérieur de la protection avec une clé de 17mm. **LA PROTECTION DOIT ETRE POSITIONNEE COMME EN “C” AVEC LE COTE ARRONDI LE PLUS GROS EN DIRECTION DE L’AVANT DE LA MOTO.** Tourner un peu plus afin d’accentuer légèrement la compression. Faire un quart de tour. Serrer à 40Nm de couple (Ne pas excéder cette valeur, car cela pourrait endommager la moto et le boulon).
- Du coté droit de la moto, enlever le boulon moteur et insérer l’outil de marquage (article 8 – T0011) dans le trou pour que le point d’extrémité se place à l’endroit où le panneau de carénage se place lorsqu’il est monté sur la moto, voir photo 16.
- Remonter le panneau de carénage sur la moto et presser légèrement le panneau vers l’outil de marquage pour laisser une marque sur le panneau. Enlever le carénage de la moto, il doit y avoir une marque à l’intérieur. En utilisant une scie-trou 28mm, percer un trou pilote sur la marque (seulement un trou pilote).
- Remonter le carénage sur la moto, en veillant à ce que l’outil de marquage soit positionné au centre du trou pilote. Une fois satisfait, ouvrir le trou à l’aide d’une scie trou de 28mm, voir photo 17. Ebarber le trou en utilisant un knife aiguisé ou du papier Emery en faisant attention à ne pas marquer l’extérieur du carénage.
- Enlever l’outil de marquage.
- Remonter le carénage sur la moto, en procédant à l’inverse du démontage pour remonter les boulons.
- La protection crash peut maintenant être montée. Glisser une des rondelles 10mm (article 3) sur le boulon M10 x 1.25 x 110mm (article 10) de façon à ce que la rondelle se place contre le boulon.
- Glisser une des petites entretoises (article 4 – S0293 – 5mm de long) sur le boulon pour qu’il se place contre la rondelle tout juste insérée.
- Glisser une rondelle de blocage (article 5) sur le boulon pour qu’il se place contre l’entretoise tout juste insérée.
- Glisser ensuite le boulon avec ses rondelles dans la protection crash (article 6) pour que la tête du boulon et les rondelles se placent dans le contre alésage de la bobine.
- Placer l’entretoise plus courte (article 9 – S1019 – 20mm de long) sur l’extrémité du filetage et positionnez la dans le trou du carénage puis serrer dans le trou du cadre, voir photo 18.
- Serrer le boulon de la protection jusqu’à ce que vous sentiez une compression de l’intérieur de la protection avec une clé de 17mm. **LA PROTECTION DOIT ETRE POSITIONNEE COMME EN “C” AVEC LE COTE ARRONDI LE PLUS GROS EN DIRECTION DE L’AVANT DE LA MOTO.** Tourner un peu plus afin d’accentuer légèrement la compression. Faire un quart de tour. Serrer à 40Nm de couple (Ne pas excéder cette valeur, car cela pourrait endommager la moto et le boulon).

R&G Racing

Unit 1, Shelley’s Lane, East Worldham, Alton, Hampshire, GU34 3AQ

Tel: +44 (0)1420 89007 Fax: +44 (0)1420 87301 www.rg-racing.com Email: info@rg-racing.com



- Vérifier que le carénage soit correctement fixé, et que les clignotants aient été reconnectés et fonctionnent correctement.
- Si cela n'est pas déjà fait, placez un sticker de caoutchouc dans le creux des bouchons de chaque protection crash.
- Placer les 2 capuchons dans les 2 protections.

Notice disponible au téléchargement sur www.rg-racing.com

CONSUMER NOTICE

The catalogue description and any exhibition of samples are only broad indications of the Products and R&G may make design changes which do not diminish their performance or visual appeal and supplying them in such state shall conform to the order. The Buyer acknowledges no representation or warranty (other than as to title) has been given or will apply to the Products other than those in R&G's order or confirmation and the Buyer confirms it has chosen the Products as being of merchantable quality and suitable for its particular purposes. Where R&G fits the Products or undertakes other services it shall exercise reasonable skill and care and rectify any fault free of charge unless the workmanship has been disturbed. The Buyer is responsible for ensuring that the warranty on the motorcycle is not affected by the fitting of the Products. On return of any defective Products R&G shall at its option either supply a replacement or refund the purchase money but shall not be liable if the Products have been modified or used or maintained otherwise than in accordance with R&G's or manufacturer's instructions and good engineering practice or if the defect arises from accident or neglect. Other than identified above and subject to R&G not limiting its liability for causing death and personal injury, it shall not be liable for indirect or consequential loss and otherwise its liability shall be limited to the amounts paid by the Buyer for the Products or the fitting or service concerned. These terms do not affect the Buyer's statutory rights.

R&G RACING RETURNS POLICY (NON-FAULTY GOODS)

Returns must be pre-authorized (if not pre-authorized the return will be rejected). Goods may only be returned direct to us if they were purchased direct from us (customer must prove if necessary). Otherwise to be returned to original vendor. Goods must be in re-sellable condition, in the opinion of R&G Racing. All returns are subject to a 25% restocking and handling fee (25% of the gross value exc. P&P – at the prevailing price at time of purchase). The customer must pay any and all carriage charges. No returns of discontinued products, unless within 14 days of purchase. This policy does not affect your statutory rights and does not refer to faulty goods.

R&G Racing

Unit 1, Shelley's Lane, East Worldham, Alton, Hampshire, GU34 3AQ

Tel: +44 (0)1420 89007 Fax: +44 (0)1420 87301 www.rg-racing.com Email: info@rg-racing.com